

Effective Date: January 1, 2012
Rev. 1



Middle East List Prices
for
Grooved Mechanical Products

Table of Contents
Section 1 – Introduction

Table of Contents	2-4
GRINNELL Gasket Styles, Grades and Recommendations	5

Section 2 – Couplings and Fittings

#772 Rigid Coupling with Grade "E" EPDM Gasket	6
#772 Rigid Coupling with Grade "E" EPDM Tri-Seal Gasket	7
#577 Rigid Coupling with Grade "E" EPDM	8
#577 Rigid Coupling with Grade "T" Nitrile Gasket	8
#577 Rigid Tri-Seal Coupling with Grade "E" EPDM Tri-Seal Gasket	9
#577 Rigid Coupling - WRAS Recommended for Potable Water	9
#705 Flexible Coupling with Grade "E" EPDM Gasket	10
#705 Flexible Coupling with Grade "E" EPDM Tri-Seal Gasket	11
#707 Heavy-Duty Flexible Coupling with Grade "E" EPDM or Grade "T" Nitrile Gasket	12
#707 Heavy-Duty Flexible Coupling with Grade "E" EPDM Tri-Seal Gasket	13
#716 Reducing Coupling with Grade "E" EPDM Gasket	13
#702 Outlet Coupling Grade "E" Gasket, Female Threaded End, Painted*	14
#702 Outlet Coupling Grade "E" Gasket, Male Threaded End, Painted*	14
#702 Outlet Coupling Grade "E" Gasket, Grooved End, Painted*	15
#770 High Pressure Rigid Coupling with Grade "E" EPDM Gasket	16
#780 Snap Coupling with Grade "E" EPDM Gasket	16
#71 Grooved Flange Adapter ANSI 150 lbs. with Grade "E" EPDM Gasket	17
#71 Grooved Flange Adapter DN10/DN16 with Grade "E" EPDM Gasket	17
#210 and #310 Grooved 90° Elbow	18
#201 and #301 Grooved 45° Elbow	19
#212 and #312 Grooved 22½° Elbow	20
#211 and #311 Grooved 11¼° Elbow	21
#210LR and #310LR Grooved 90° Long Radius Elbow	22
#201LR and #301LR Grooved 45° Long Radius Elbow	23
#310 - 3D, #310 - 5D, #310 - 6D Long Radius 90° Elbow, Painted	24
#306 - 3D, #306 - 5D, #306 - 6D, Long Radius 60° Elbow, Painted	24
#301 - 3D, #301 - 5D, #301 - 6D, Long Radius 45° Elbow, Painted	25
#303 - 3D, #303 - 5D, #303 - 6D, Long Radius 30° Elbow, Painted	25
#312 3D, #312 - 5D, #312 - 6D, Long Radius 22½° Elbow, Painted	26
#311 - 3D, #311 - 5D, #311 - 6D, Long Radius 11¼° Elbow, Painted	26
#316 Reducing Base Support Elbow, Groove x Flange	27
#315 Groove x Male Thread – Adapter 90° Elbow	27
#219 and #319 Grooved Tee	28
#320 Groove x Male Thread Tee	28
#221 Grooved Reducing Tee	29
#321 Grooved Reducing Tee	30 - 31
#323 Groove x Male Thread – Reducing Tee with Threaded Branch	32 - 33
#250 Grooved Concentric Reducer	34
#350 Grooved Concentric Reducer	35
#251 Grooved Eccentric Reducer	36
#351 Grooved Eccentric Reducer	36 - 37
#372 Groove x Male Thread – Reducer	38
#391 Groove x Male Thread – Adapter Nipple	39
#392 Groove x Groove – Adapter Nipple	39
#393 Groove x Plain – Adapter Nipple	40
#395 Hose Adapter Nipple, Groove x Hose	40
#380 Female Thread Adapter, Groove x Female Pipe Thread	41
#314 Grooved Lateral	41
#325 Grooved Reducing Lateral	42
#324 Grooved Wye	43
#331 Grooved Reducing Tee Wye	43
#330 Grooved Tee Wye	44
#327 Grooved Cross	45
#260 and #360 Grooved Cap	46
#260 Cast – Grooved Cap with ½" Tap	46
#363 Cast – Grooved Cap with ¾" Tap	47
#364 Cast – Grooved Cap with 1" Tap	47
#361 Cast – Grooved Cap with 1-½" Tap	48
#362 Cast – Grooved Cap with 2" Tap	48
#341 Groove x Flange – Adapter 150#	49
#342 Groove x Flange – Adapter 300#	49
#397 Groove x Groove – Swaged Nipple	50
#398 Groove x Male Thread – Swaged Nipple	51
#399 Groove x Plain – Swaged Nipple	52

Section 3 – Mechanical Tees

#730 Mechanical Tee – Threaded with Grade "E" Gasket	53 - 54
#730 Mechanical Tee – Grooved with Grade "E" Gasket	55
#730 Mechanical Cross – Threaded with Grade "E" Gasket	56
#730 Mechanical Cross – Grooved with Grade "E" Gasket	57

*As used in this Table of Contents and Price Book, the designation "domestic" is meant to identify where the last point of manufacture or assembly takes place for a product. However, this designation does not represent compliance with any government regulatory standards or contract specifications and should not be relied upon for such purposes. You must request separate certifications or other representations concerning the specific regulatory standards or contract specifications which apply for your application.

In order to request regulatory or specification certifications/ representations please contact Tyco Trade Compliance at 215-362-0700 for assistance. In your request, please identify the part numbers and specific regulatory standards or contract specifications about which you are inquiring.

See latest catalog or technical data sheets for specific approvals, listings, and design parameters.
 POA = Price on availability. Prices subject to change without notice.

Table of Contents
Section 4 – Valves

#B302 Grooved Butterfly Valve – EPDM	58
#BN302 Grooved Butterfly Valve – EPDM NSF Approved	58
#B302 Grooved Butterfly Valve – Accessories	59
#B308 Grooved Butterfly Valve, EPDM – D.I. Nickel Plated, Gear Operator	59
#B8101 Low Profile Butterfly Valve with Lever Handle	60
#BV835 Grooved Ball Valve with Lever Handle	60
#590 Grooved Check Valve, EPDM	61
#CV-1 Grooved Check Valve, EPDM	61
#CV-1 Grooved Check Valve, Spare Parts	62
#TD830, Triple Duty Valve, Flow Control Type	62

Section 5 – Circuit Balancing Valves

#CB800 Solder x Solder – Circuit Balancing Valve	63
#CB800 Thread x Thread – Circuit Balancing Valve	63
#CB800 Groove x Groove – Circuit Balancing Valve	64
#CB800 Flange x Flange – Circuit Balancing Valve	64
#CB800 Circuit Balancing Valves – Accessories	65
Insulation Kits for #CB800 Circuit Balancing Valves	65
Differential Measuring Computer	65

Section 6 – Accessories

#S853 Grooved Wye Strainer	66
#S855 Grooved Tee – Type Strainer	66
#S810 Groove x Flange ANSI – Suction Diffuser	67

Section 7 – Copper Systems

#640 Pivot-Bolt Rigid Couplings with Grade "EHT" EPDM Center-Stop Push-On Style Gasket	68
#672 Rigid Couplings with Grade "EN" Tri-Seal Gasket	68
#61 Flange Adapter with Grade "EN" EPDM Gasket	68
#610 Grooved 90° Elbow	69
#601 Grooved 45° Elbow	69
#619 Tee	69
#660 Cap	70
#650 Grooved Concentric Reducer	70
#652 Grooved Reducer Grooved x Cup	70
#621 Reducing Tee Grooved x Grooved x Grooved	71
#618 Reducing Tee Grooved x Grooved x Cup	71
#407GG Dielectric Waterway Transition Fitting Grooved x Grooved, IPS x CTS	72
#407GT Dielectric Waterway Grooved x Thread	72
#407T Dielectric Waterway Male Thread x Male Thread	73
#B800 Copper System Butterfly Valve Grooved, EPDM, with Lever Handle or Gear Operated	73
Roll Groover Mini-Mite 2" – 8" Copper Tube #1039-66	73

Section 8 – Stainless Steel Systems

#472 Rigid Coupling 316 SS with Grade "EN" Gasket	74
#472 Rigid Coupling 316 SS with Grade "EN" Tri-seal Gasket	74
#405 Flexible Coupling 316 SS with Grade "EN" Gasket	75
#405 Flexible Coupling 316 SS with Grade "EN" Tri-Seal Gasket	75
#410 90° Elbow 304 SS & 316 SS, Sch. 10	76
#401 45° Elbow, 304 SS & 316 SS, Sch. 10	76
#419 Tee, 304 SS & 316 SS, Sch. 10	77
#460 Cap, 304 SS & 316 SS, Sch. 10	77
#421 Reducing Tee, 304 SS & 316 SS, Sch. 10	78
#441 Flange Adapter Nipple 150 lbs. 304 SS, Sch. 10	79
#441 Flange Adapter Nipple PN16/PN10 304 SS, Sch. 10	79
#450 Concentric Reducer, 304 SS & 316 SS, Sch. 10	80
#451 Eccentric Reducer, 304 SS & 316 SS, Sch. 10	81

Section 9 – Plain-End Systems

#909 Plain End Coupling with Grade "E" EPDM Gasket	82
#910 Plain End 90° Elbow	82
#910LR Plain End Long Radius 90° Elbow	83
#901 Plain End 45° Elbow	83
#901LR Plain End Long Radius 45° Elbow	83
#919 Plain End Tee	84
#927 Plain End Cross	84
#924 Plain End True Wye	84
#960 Plain End Cap (Bull Plug)	85
#914 Plain End Lateral	85
#999 Plain End Swaged Nipple	86
#991, 992, 993 Adapter Nipples	86
#941, 942 Flange Adapters	87 – 88
#921 Reducing Tee Plain End	88

**As used in this Table of Contents and Price Book, the designation "domestic" is meant to identify where the last point of manufacture or assembly takes place for a product. However, this designation does not represent compliance with any government regulatory standards or contract specifications and should not be relied upon for such purposes. You must request separate certifications or other representations concerning the specific regulatory standards or contract specifications which apply for your application.*

In order to request regulatory or specification certifications/ representations please contact Tyco Trade Compliance at 215-362-0700 for assistance. In your request, please identify the part numbers and specific regulatory standards or contract specifications about which you are inquiring.

www.grinnell.com

*See latest catalog or technical data sheets for specific approvals, listings, and design parameters.
 POA = Price on availability. Prices subject to change without notice.*

Select Middle East Region on the map

Introduction
Couplings & Fittings
Mechanical Tees
Valves
Circuit Balancing Valves
Accessories
Copper Systems
Stainless Steel Systems
Plain End Systems
HDPE Systems
G-MINE PVC Systems
Gaskets & Spare Parts
Preparation Equipment
Miscellaneous
Indexes

Table of Contents
Section 10 – HDPE Systems

#9094 HDPE Flange Coupling with Grade "E" EPDM Gasket	89
#9095 HDPE Coupling with Grade "E" EPDM Gasket	89
#9097 HDPE Transition Coupling	89

Section 11 – G-MINE PVC Systems

#72900 SDR Pipe	90
#72901 SDR Pipe with Coupling	90
#72904 Coupling	91
#72905 Spline x Solvent Weld Coupling	91
#72919 Male Thread x Female Thread Reducing Coupling	91
#72930 Outlet Coupling	92
#72940 Male Thread x Female Thread Outlet Coupling	92
#72906 Spline x Plain End Nipple	93
#72907 Spline x Groove Nipple	93
#72908 Spline x Male Thread Nipple	93
#72909 Plain End x Male Thread Nipple	94
#72911 Spline x Spline Nipple	94
#72910 90° Elbow	94
#72912 45° Elbow	95
#72913 90° Sweep	95
#72914 45° Sweep	95
#72915 Cap	96
#72916 Flange Adapter 150psi	96
#72917 Tee	96
#72918 Reducing Tee	97
#72999 Spline	97
#ITGM Insertion Tool	98
#72899 Replacement Gaskets	98

Section 12 – Gaskets & Spare Parts

Replacement Gaskets – EPDM "E" Gaskets, For #577, #772, #770, #705, #707	99
Replacement Tri-Seal Gaskets – EPDM "E" Gaskets, For #577, #772, #770, #705, #707	100
Replacement WRAS Gaskets – EPDM "E" Gaskets, For #577, Recommended for Potable Water	101
Replacement Gaskets – EPDM "E" Gaskets For # 716 Reducing Coupling	101
Replacement Gaskets – EPDM "E" Gaskets For #780 Snap Coupling	102
#71 Flange Adapter Replacement "E" EPDM Gasket	102
#71 Flange Washer Adapter Carbon Steel	103
#730 Replacement "E" EPDM Gasket	104 – 105
Replacement Gaskets – Grade "EN" Tri-Seal (for #672 Coupling)	105
Replacement Gaskets – Grade "EHT" EPDM Center-Stop Push-On Style Gasket (for #640 Coupling)	105
Replacement Gaskets – Grade "EN" EPDM (for #61 Flange Adapter)	106
Phenolic Washer (for #61 Flange Adapter)	106
Replacement Gaskets – EPDM "E" Gaskets For #909 Plain End Coupling	107
HDPE – #9094 Replacement Gaskets "E"	107
HDPE – #9095 Replacement Gaskets "E"	107
HDPE – #9097 Replacement Gaskets "E"	108
Coupling Nut and Bolt Kit	108
#71 Nut, Bolt, and Gasket Kit	108
Pipe Tape	109
GRINNELL Gasket Lubricant	109
GRINNELL Silicone Gasket Lubricant	109

Section 13 – Preparation Equipment

Roll Grooving Machine Selection Chart	110
Accessories	110
Roll Selection Chart	111

Section 14 – Miscellaneous

Grooved Couplings – Pieces Per Carton/Case	112
Grooved Fittings – Pieces Per Carton/Case	112
Grooved Fittings – Pieces Per Carton/Case	113
Copper System Grooved Couplings – Pieces Per Carton/Case	113

Section 15 – Indices

Part Number Index	114 – 121
Model Number Index	122 – 123

**As used in this Table of Contents and Price Book, the designation "domestic" is meant to identify where the last point of manufacture or assembly takes place for a product. However, this designation does not represent compliance with any government regulatory standards or contract specifications and should not be relied upon for such purposes. You must request separate certifications or other representations concerning the specific regulatory standards or contract specifications which apply for your application.*

In order to request regulatory or specification certifications/ representations please contact Tyco Trade Compliance at 215-362-0700 for assistance. In your request, please identify the part numbers and specific regulatory standards or contract specifications about which you are inquiring.

GRINNELL Gasket Styles, Grades and Recommendations

Standard

The standard style gasket, with a “C” shape configuration, is the most commonly used. It is provided as the standard gasket in the Figure 577, 705, 707, 770, 772, 405, and 472 GRINNELL Couplings. The gasket is available in Grade “E” and “EN” EPDM Grade “T” Nitrile, Grade “L” Silicone, and Grade “O” Fluoroelastomer.



Tri-Seal

The tri-seal gasket is designed to close off the gap or gasket cavity. This is accomplished by positioning the center “rib” of the gasket over the gap between the pipes. The tri-seal gasket has two tapered sealing edges in addition to the center rib for additional strength and sealing. The Tri-Seal gasket can be used with the Figure 577, 705, 707, 770, 772, 405, 472, and 672 GRINNELL Couplings. The gasket is available in Grade “E”, “EN” EPDM and Grade “T” Nitrile.



Note: Rigid couplings are recommended for vacuum and low temperature applications

Reducing Coupling

The reducing gasket is provided with ribs used to position the larger pipe so that the sealing lip is located on the sealing surface of the pipe. This gasket is used only with the Figure 716 GRINNELL Reducing Coupling and is available in Grade “E” EPDM and Grade “T” Nitrile.



Note: Reducing couplings are not recommended for low temperature applications.

Center-Stop Push-On

The Grade “EHT” EPDM Center-Stop, Push-On Style Gasket is specially designed for easy installation of the GRINNELL Figure 640 Pivot-Bolt Coupling.



Plain End Coupling

This gasket is designed for use with the Figure 909 and Figure 9095 Plain End Coupling.



Flange Adapter

This gasket is specifically designed for use with the Figure 71 and 61 Flange Adapter. The gasket has an optimal amount of rubber to provide a dependable seal between both the pipe and mating surface. The gasket is available in Grade “E” EPDM and Grade “T” Nitrile.

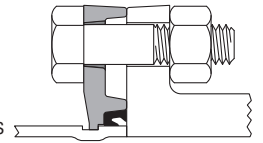

Mechanical Tee, Cross and Strap

The gasket provides a compression type seal, which is designed to conform to the exterior curve (OD) of the pipe. This design is unique to both the Figure 730 Mechanical Tee (threaded and grooved) and Figure 40-5 Strap. The gasket is available in Grade “E” EPDM and Grade “T” Nitrile.

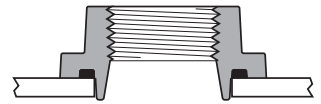

Note: When used in low temperature applications, use a petroleum-free silicone based lubricant, otherwise no lubricant is required on Mechanical Tee and Strap gaskets.

Outlet Coupling

This gasket is specifically designed for use with the GRINNELL Figure 702 Outlet Coupling.

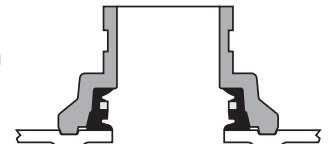

GRINNELL gaskets are designed exclusively for use with GRINNELL manufactured coupling housings. The mixing of other manufacturer’s gaskets or housings with GRINNELL gaskets or housings may result in pipe joint leakage or failure and will void the GRINNELL Mechanical Products limited warranty.

The Gasket Recommendation Table has been developed to maximize service life. The table was developed from information supplied by the elastomer material manufacturers, reference technical literature, and testing conducted by GRINNELL Mechanical Products.

In evaluating the gasket grade for intended service, consider the following: system operating temperature, fluid or solution concentration, and duration of service.

All gasket recommendations are based on a temperature of 70°F (21°C) unless otherwise noted.

When considering combinations of service solutions, consult Technical Services and Mechanical Services. (Phone 866-500-4768).

GRINNELL Mechanical Products for recommendations for services not listed. Gasket recommendations apply to GRINNELL gaskets and valves only.

Grade	Temperature Range	Compound	Color Code	General Service Application
“E”	-30°F to 230°F (-34°C to 110°C)	EPDM	Green	Hot water, dilute acids, alkalis, oil free air, and many chemical services not involving petroleum products. Excellent oxidation resistance. NOT FOR USE WITH HYDROCARBONS. NOT RECOMMENDED FOR STEAM SERVICE.
“E” Tri-Seal	-30°F to 230°F (-34°C to 110°C)	EPDM	Green	Hot water, dilute acids, alkalis, and many chemical services not involving petroleum products. Excellent oxidation resistance. NOT FOR USE WITH HYDROCARBONS. Recommended for low temperature and vacuum services.
“EN” and “EN” Tri-Seal IPS Pipe	Cold and Hot Potable Water up to 180°F (82°C)	EPDM	Green/Yellow Stripe	IPS Sizes Only , NSF 61 Approved for potable water. NOT RECOMMENDED FOR HYDROCARBONS.
“EN” Tri-Seal Copper Tubing	Cold and Hot Potable Water up to 180°F (82°C)	EPDM	Copper	CTS Sizes Only , NSF 61 Approved for potable water. NOT RECOMMENDED FOR HYDROCARBONS.
“EHT” Center-Stop Push-On Style Copper Tubing	For closed-loop heating systems -30°F to 250°F (-34°C to 120°C) Potable Water up to 180°F (82°C)	EPDM	Red and Copper Striped	CTS Sizes Only , NSF 61 Approved for potable water. Recommended for use in low temperature and vacuum systems NOT RECOMMENDED FOR HYDROCARBONS.
“T” and “T” Tri-Seal	-20°F to 180°F (-29°C to 82°C)	Nitrile	Orange	Petroleum products, vegetable oils, mineral oils and air with oils. High-End oil vapor temperature, decrease to 150°F (66°C) Not Recommended for Hot Water Systems. Not Recommended for Hot Dry Air Systems.
“O”	+20°F to 300°F (-7°C to 149°C)	Fluoroelastomer	Blue	Oxidizing acids, petroleum products, hydraulic fluids, lubricants, halogenated hydrocarbons.
“L”	-30°F to 350°F (-34°C to 177°C)	Silicone *	Red Gasket	Air without hydrocarbons, dry heat.

* To prevent gasket from deteriorating, NEVER use silicone-based lubricants with Grade “L” Silicone gaskets

Introduction
 Couplings & Fittings
 Mechanical Tees
 Valves
 Circuit Balancing Valves
 Accessories
 Copper Systems
 Stainless Steel Systems
 Plain End Systems
 HDPE Systems
 G-MINE PVC Systems
 Gaskets & Spare Parts
 Preparation Equipment
 Miscellaneous
 Indexes

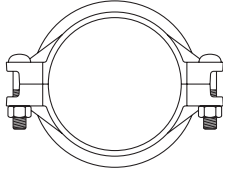
**#772 Rigid Coupling
 with Grade "E" EPDM Gasket**

Pipe Size		Painted		Galvanized	
Nominal Size	Outside Diameter	Part Number	List Price	Part Number	List Price
1 1/4"	42.4mm	772ME00421	\$18.97	772ME00422	\$22.79
1 1/2"	48.3mm	772ME00481	\$19.15	772ME00482	\$22.97
2"	60.3mm	772ME00601	\$23.74	772ME00602	\$30.73
2 1/2"	73.0mm	772ME00731	\$27.46	772ME00732	\$36.05
76.1mm	76.1mm	772ME00761	\$27.46	772ME00762	\$36.05
3"	88.9mm	772ME00891	\$32.06	772ME00892	\$42.36
4"	114.3mm	772ME01141	\$45.60	772ME01142	\$60.25
139.7mm	139.7mm	772ME01391	\$59.17	772ME01392	\$78.34
5"	141.3mm	772ME01411	\$59.17	772ME01412	\$78.34
165.1mm	165.1mm	772ME01651	\$79.21	772ME01652	\$104.01
6"	168.3mm	772ME01681	\$79.21	772ME01682	\$104.01
8"	219.1mm	772ME02191	\$115.74	772ME02192	\$148.72
10"	273.0mm	772ME02731	\$178.96	772ME02732	\$242.61
12"	323.9mm	772ME03241	\$205.90	772ME03242	\$251.82
14"	355.6mm	772AE03551	\$370.91	772AE03552	\$488.68
16"	406.4mm	772AE04061	\$483.69	772AE04062	\$573.08
18"	457.2mm	772AE04571	\$559.20	772AE04572	\$744.12
20"	508.0mm	772AE05081	\$740.71	772AE05082	\$944.02
24"	609.6mm	772AE06101	\$1,252.45	772AE06102	\$1,606.86

Notes

For price and availability for the couplings with Grade "T" Nitrile gaskets, contact GRINNELL Mechanical Products.

 Orders for items in shaded areas *cannot* be cancelled or returned.

Technical Data Sheet: G140

**#772 Rigid Coupling
 with Grade "E" EPDM Tri-Seal Gasket**

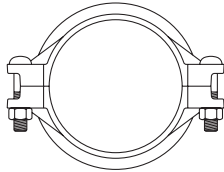

<i>Pipe Size</i>		<i>Painted</i>		<i>Galvanized</i>	
<i>Nominal Size</i>	<i>Outside Diameter</i>	<i>U.S. Part Number</i>	<i>List Price</i>	<i>U.S. Part Number</i>	<i>List Price</i>
1 ¹ / ₄ "	42.4mm	77213E3S	\$25.03	77213E3GS	\$30.58
1 ¹ / ₂ "	48.3mm	77215E3S	\$26.75	77215E3GS	\$32.28
2"	60.3mm	77220HE3S	\$29.36	77220HE3GS	\$36.85
2 ¹ / ₂ "	73.0mm	77225HE3S	\$34.33	77225HE3GS	\$43.48
3"	88.9mm	77230HE3S	\$40.19	77230HE3GS	\$51.17
4"	114.3mm	77240HE3S	\$56.30	77240HE3GS	\$71.74
5"	141.3mm	77250E3S	\$72.31	77250E3GS	\$92.53
6"	168.3mm	77260E3S	\$94.86	77260E3GS	\$120.98
8"	219.1mm	77280E3S	\$132.17	77280E3GS	\$166.43
10"	273.0mm	77210E3S	\$196.13	77210E3GS	\$261.09
12"	323.9mm	77212E3S	\$218.57	77212E3GS	\$291.75
14"	355.6mm	77214E3S	\$370.91	77214E3GS	\$488.68
16"	406.4mm	77216E3S	\$483.69	77216E3GS	\$573.08
18"	457.2mm	77218E3S	\$559.20	77218E3GS	\$744.12
20"	508.0mm	77221E3S	\$740.71	77221E3GS	\$944.02
24"	609.6mm	77224E3S	\$1,252.45	77224E3GS	\$1,606.86

Notes

For price and availability for the couplings with Grade "T" Nitrile gaskets, contact GRINNELL Mechanical Products.

Orders for items in shaded areas *cannot* be cancelled or returned.

Technical Data Sheet: G140

Introduction
 Couplings & Fittings
 Mechanical Tees
 Valves
 Circuit Balancing Valves
 Accessories
 Copper Systems
 Stainless Steel Systems
 Plain End Systems
 HDPE Systems
 G-MINE PVC Systems
 Gaskets & Spare Parts
 Preparation Equipment
 Miscellaneous
 Indexes

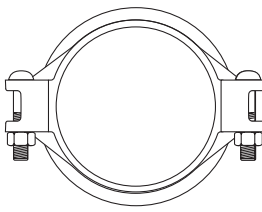
**#577 Rigid Coupling
 with Grade "E" EPDM**

	Pipe Size		Painted		Galvanized	
	Nominal Size	Outside Diameter	Grade "E" EPDM	List Price	Grade "E" EPDM	List Price
	1"	33.4mm	577ME00341	\$12.74	577ME00342	\$14.68
	1 1/4"	42.4mm	577ME00421	\$12.07	577ME00422	\$14.68
	1 1/2"	48.3mm	577ME00481	\$11.81	577ME00482	\$15.56
	2"	60.3mm	577ME00601	\$12.01	577ME00602	\$15.56
	2 1/2"	73.0mm	577ME00731	\$13.89	577ME00732	\$17.25
	76.1mm	76.1mm	577ME00761	\$13.89	577ME00762	\$17.25
	3"	88.9mm	577ME00891	\$15.99	577ME00892	\$19.63
	4"	114.3mm	577ME01141	\$21.98	577ME01142	\$27.05
	139.7mm	139.7mm	577ME01391	\$32.16	577ME01392	\$40.26
	5"	141.3mm	577ME01411	\$32.16	577ME01412	\$40.26
	165.1mm	165.1mm	577ME01651	\$32.85	577ME01652	\$41.40
	6"	168.3mm	577ME01681	\$32.85	577ME01682	\$41.40
	8"	219.1mm	577ME02191	\$56.93	577ME02192	\$71.55

Note

Max pressure is 20.7 bar (300 psi)

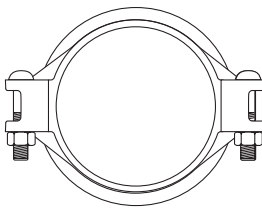
Technical Data Sheet: TFP1854
**#577 Rigid Coupling
 with Grade "T" Nitrile Gasket**

	Pipe Size		Painted		Galvanized	
	Nominal Size	Outside Diameter	Grade "T" Nitrile	List Price	Grade "T" Nitrile	List Price
	1"	33.4mm	577MB00341	POA	577MB00342	POA
	1 1/4"	42.4mm	577MB00421	POA	577MB00422	POA
	1 1/2"	48.3mm	577MB00481	POA	577MB00482	POA
	2"	60.3mm	577MB00601	POA	577MB00602	POA
	2 1/2"	73.0mm	577MB00731	POA	577MB00732	POA
	76.1mm	76.1mm	577MB00761	POA	577MB00762	POA
	3"	88.9mm	577MB00891	POA	577MB00892	POA
	4"	114.3mm	577MB01141	POA	577MB01142	POA
	139.7mm	139.7mm	577MB01391	POA	577MB01392	POA
	5"	141.3mm	577MB01411	POA	577MB01412	POA
	165.1mm	165.1mm	577MB01651	POA	577MB01652	POA
	6"	168.3mm	577MB01681	POA	577MB01682	POA
	8"	219.1mm	577MB02191	POA	577MB02192	POA

Notes

Max pressure is 20.7 bar (300 psi).

 Orders for items in shaded areas *cannot* be cancelled or returned.

Technical Data Sheet: TFP1854

All standard couplings can be provided with stainless steel nuts and bolts upon request.
 See latest catalog or technical data sheets for specific approvals, listings, and design parameters.
 POA = Price on availability. Prices subject to change without notice.

#577 – Rigid Tri-Seal Coupling
with Grade “E” EPDM Tri-Seal Gasket Recommended for
Dry Pipe Systems and Freezer Applications – Use Silicone Lubricant

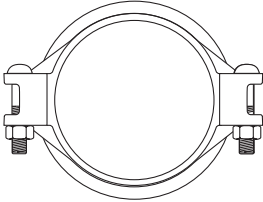
	Pipe Size		Painted		Galvanized	
	Nominal Size	Outside Diameter	Part Number	List Price	Part Number	List Price
	1"	33.4mm	577MT00341	POA	577MT00342	POA
	1 1/4"	42.4mm	577MT00421	POA	577MT00422	POA
	1 1/2"	48.3mm	577MT00481	POA	577MT00482	POA
	2"	60.3mm	577MT00601	POA	577MT00602	POA
	2 1/2"	73.0mm	577MT00731	POA	577MT00732	POA
	76.1mm	76.1mm	577MT00761	POA	577MT00762	POA
	3"	88.9mm	577MT00891	POA	577MT00892	POA
	4"	114.3mm	577MT01141	POA	577MT01142	POA
	139.7mm	139.7mm	577MT01391	POA	577MT01392	POA
	5"	141.3mm	577MT01411	POA	577MT01412	POA
	165.1mm	165.1mm	577MT01651	POA	577MT01652	POA
	6"	168.3mm	577MT01681	POA	577MT01682	POA
	8"	219.1mm	577MT02191	POA	577MT02192	POA
Notes						
Max pressure is 20.7 bar (300 psi).						
Orders for items in shaded areas <i>cannot</i> be cancelled or returned.						
Technical Data Sheet: TFP1854						

#577 – Rigid Coupling - WRAS
Recommended for Potable Water

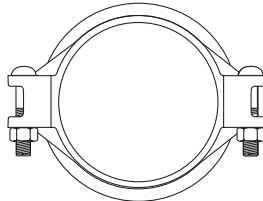
	Pipe Size		Galvanized	
	Nominal Size	Outside Diameter	Part Number	List Price
	1"	33.4mm	577MD00342	\$13.78
	1 1/4"	42.4mm	577MD00422	\$13.78
	1 1/2"	48.3mm	577MD00482	\$14.66
	2"	60.3mm	577MD00602	\$16.94
	2 1/2"	73.0mm	577MD00732	\$19.15
	76.1mm	76.1mm	577MD00762	\$19.24
	3"	88.9mm	577MD00892	\$20.02
	4"	114.3mm	577MD01142	\$30.43
	139.7mm	139.7mm	577MD01392	\$45.27
	165.1mm	165.1mm	577MD01652	\$50.68
	6"	168.3mm	577MD01682	\$50.31
	8"	219.1mm	577MD02192	\$101.57
Note				
Max pressure is 20.7 bar (300 psi)				
Technical Data Sheet: TFP1854				

*All standard couplings can be provided with stainless steel nuts and bolts upon request.
 See latest catalog or technical data sheets for specific approvals, listings, and design parameters.
 POA = Price on availability. Prices subject to change without notice.*

Introduction
 Couplings & Fittings
 Mechanical Tees
 Valves
 Circuit Balancing Valves
 Accessories
 Copper Systems
 Stainless Steel Systems
 Plain End Systems
 HDPE Systems
 G-MINE PVC Systems
 Gaskets & Spare Parts
 Preparation Equipment
 Miscellaneous
 Indexes

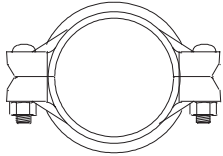
**#705 Flexible Coupling
 with Grade “E” EPDM Gasket**

<i>Pipe Size</i>		<i>Painted</i>		<i>Galvanized</i>	
<i>Nominal Size</i>	<i>Outside Diameter</i>	<i>Part Number</i>	<i>List Price</i>	<i>Part Number</i>	<i>List Price</i>
1"	33.4mm	705ME00341	\$18.72	705ME00342	\$29.24
1 ¹ / ₄ "	42.4mm	705ME00421	\$18.72	705ME00422	\$22.40
1 ¹ / ₂ "	48.3mm	705ME00481	\$16.95	705ME00482	\$21.54
2"	60.3mm	705ME00601	\$33.64	705ME00602	\$45.38
2 ¹ / ₂ "	73.0mm	705ME00731	\$40.37	705ME00732	\$56.08
76.1mm	76.1mm	705ME00761	\$40.37	705ME00762	\$56.08
3"	88.9mm	705ME00891	\$44.70	705ME00892	\$62.26
4"	114.3mm	705ME01141	\$65.23	705ME01142	\$91.97
139.7mm	139.7mm	705ME01391	\$100.19	705ME01392	\$143.69
5"	141.3mm	705ME01411	\$100.19	705ME01412	\$143.69
165.1mm	165.1mm	705ME01651	\$118.25	705ME01652	\$169.74
6"	168.3mm	705ME01681	\$118.25	705ME01682	\$169.74
8"	219.1mm	705ME02191	\$183.04	705ME02192	\$262.94
10"	273.0mm	705ME02731	\$205.45	705ME02732	\$289.85
12"	323.9mm	705ME03241	\$233.93	705ME03242	\$329.53

Note

For price and availability for the couplings with Grade “T” Nitrile gaskets, contact GRINNELL Mechanical Products.

Technical Data Sheet: G110

**#705 Flexible Coupling
 with Grade "E" EPDM Tri-Seal Gasket**

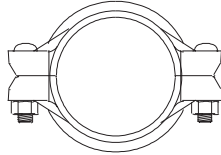

	Pipe Size		Painted		Galvanized	
	Nominal Size	Outside Diameter	U.S. Part Number	List Price	U.S. Part Number	List Price
	1 1/4"	42.4mm	70513E3S	\$19.54	70513E3GS	\$23.42
	1 1/2"	48.3mm	70515E3S	\$21.28	70515E3GS	\$27.05
	2"	60.3mm	70520E3S	\$39.22	70520E3GS	\$51.25
	2 1/2"	73.0mm	70525E3S	\$47.10	70525E3GS	\$63.44
	3"	88.9mm	70530E3S	\$52.68	70530E3GS	\$70.88
	4"	114.3mm	70540E3S	\$75.62	70540E3GS	\$103.37
	5"	141.3mm	70550E3S	\$113.04	70550E3GS	\$157.69
	6"	168.3mm	70560E3S	\$133.65	70560E3GS	\$186.32
	8"	219.1mm	70580E3S	\$199.88	70580E3GS	\$280.94
	10"	273.0mm	70510E3S	\$301.45	70510E3GS	\$376.80
	12"	323.9mm	70512E3S	\$315.80	70512E3GS	\$444.86

Notes

For price and availability for the couplings with Grade "T" Nitrile gaskets, contact GRINNELL Mechanical Products.

Orders for items in shaded areas *cannot* be cancelled or returned.

Technical Data Sheet: G110

Introduction
 Couplings & Fittings
 Mechanical Tees
 Valves
 Circuit Balancing Valves
 Accessories
 Copper Systems
 Stainless Steel Systems
 Plain End Systems
 HDPE Systems
 G-MINE PVC Systems
 Gaskets & Spare Parts
 Preparation Equipment
 Miscellaneous
 Indexes

#707 Heavy-Duty Flexible Coupling
with Grade “E” EPDM or Grade “T” Nitrile Gasket

Pipe Size		Painted				Galvanized			
Nominal Size	Outside Diameter	Part Numbers			List Price	Part Numbers			List Price
		U.S. Part No. Grade “E” EPDM	European Part No. Grade “E” EPDM	Grade “T” Nitrile		U.S. Part No. Grade “E” EPDM	European Part No. Grade “E” EPDM	Grade “T” Nitrile	
1"	33.4mm	70701ES	707AE00341	70701TS	\$21.77	70701EGS	707AE00342	70701TGS	\$29.26
1 1/4"	42.4mm	–	707AE00421	–	POA	–	707AE00422	–	POA
1 1/2"	48.3mm	70715ES	707AE00481	70715TS	\$31.81	70715EGS	707AE00482	70715TGS	\$42.58
2"	60.3mm	70720ES	707AE00601	70720TS	\$33.64	70720EGS	707AE00602	70720TGS	\$45.38
2 1/2"	73.0mm	70725ES	707AE00731	70725TS	\$40.37	70725EGS	707AE00732	70725TGS	\$56.08
76.1mm	76.1mm	–	707AE00761	–	\$40.37	–	707AE00762	–	\$56.08
3"	88.9mm	70730ES	707AE00891	70730TS	\$44.70	70730EGS	707AE00892	70730TGS	\$62.26
4"	114.3mm	70740ES	707AE01141	70740TS	\$65.23	70740EGS	707AE01142	70740TGS	\$91.97
139.7mm	139.7mm	–	707AE01391	–	\$100.19	–	707AE01392	–	\$143.69
5"	141.3mm	70750ES	707AE01411	70750TS	\$100.19	70750EGS	707AE01412	70750TGS	\$143.69
165.1mm	165.1mm	–	707AE01651	–	\$118.25	–	707AE01652	–	\$169.74
6"	168.3mm	70760ES	707AE01681	70760TS	\$118.25	70760EGS	707AE01682	70760TGS	\$169.74
8"	219.1mm	70780ES	707AE02191	70780TS	\$193.10	70780EGS	707AE02192	70780TGS	\$277.39
10"	273.0mm	70710ES	707AE02731	70710TS	\$266.72	70710EGS	707AE02732	70710TGS	\$380.79
12"	323.9mm	70712ES	707AE03241	70712TS	\$303.66	70712EGS	707AE03242	70712TGS	\$432.81
14"	355.6mm	70714ES	707AE03551	70714TS	\$448.43	70714EGS	707AE03552	70714TGS	\$624.07
16"	406.4mm	70716ES	707AE04061	70716TS	\$587.48	70716EGS	707AE04062	70716TGS	\$793.98
18"	457.2mm	70718ES	707AE04571	70718TS	\$688.08	70718EGS	707AE04572	70718TGS	\$950.34
20"	508.0mm	70721ES	707AE05081	70721TS	\$774.29	70721EGS	707AE05082	70721TGS	\$986.68
24"	609.6mm	70724ES	707AE06101	70724TS	\$1,294.94	70724EGS	707AE06102	70724TGS	\$1,761.74

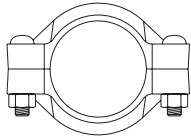
Note

 Orders for items in shaded areas *cannot* be cancelled or returned.

Technical Data Sheet: G130

**#707 Heavy-Duty Flexible Coupling
 with Grade “E” EPDM Tri-Seal Gasket**

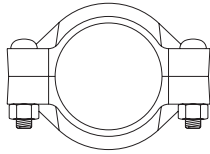

Pipe Size		Painted		Galvanized	
Nominal Size	Outside Diameter	U.S. Part Number	List Price	U.S. Part Number	List Price
1 1/2"	48.3mm	70715E3S	\$36.13	70715E3GS	\$47.12
2"	60.3mm	70720E3S	\$39.21	70720E3GS	\$51.31
2 1/2"	73.0mm	70725E3S	\$47.25	70725E3GS	\$63.22
3"	88.9mm	70730E3S	\$52.70	70730E3GS	\$70.88
4"	114.3mm	70740E3S	\$75.68	70740E3GS	\$103.44
5"	141.3mm	70750E3S	\$112.03	70750E3GS	\$160.55
6"	168.3mm	70760E3S	\$133.76	70760E3GS	\$190.05
8"	219.1mm	70780E3S	\$209.60	70780E3GS	\$295.41
10"	273.0mm	70710E3S	\$284.19	70710E3GS	\$399.71
12"	323.9mm	70712E3S	\$322.31	70712E3GS	\$453.04
14"	355.6mm	70714E3S	\$448.43	70714E3GS	\$624.07
16"	406.4mm	70716E3S	\$587.48	70716E3GS	\$793.98
18"	457.2mm	70718E3S	\$688.08	70718E3GS	\$950.34
20"	508.0mm	70721E3S	\$774.29	70721E3GS	\$986.68
24"	609.6mm	70724E3S	\$1,294.94	70724E3GS	\$1,761.74

Notes

For price and availability for the couplings with Grade “T” Nitrile gaskets, contact GRINNELL Mechanical Products.

Orders for items in shaded areas **cannot** be cancelled or returned.

Technical Data Sheet: G130

**#716 Reducing Coupling
 with Grade “E” EPDM Gasket**

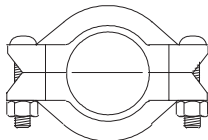

Pipe Size		Painted		Galvanized	
Nominal Size	Outside Diameter	Part Number	List Price	Part Number	List Price
2" x 1 1/2"	60.3 x 48.3mm	716AE20151	\$47.50	716AE20152	\$58.17
2 1/2" x 2"	73.0 x 60.3mm	716AE25201	\$61.90	716AE25202	\$79.57
76.1mm x 2"	76.1 x 60.3mm	716ME26201	\$74.37	716ME26202	\$95.93
3" x 2"	88.9 x 60.3mm	716AE30201	\$71.06	716AE30202	\$91.77
3" x 2 1/2"	88.9 x 73.0mm	716AE30251	\$61.07	716AE30252	\$79.35
3" x 76.1mm	88.9 x 76.1mm	716ME30261	\$74.37	716ME30262	\$95.93
4" x 2"	114.3 x 60.3mm	716AE42201	\$113.65	716AE42202	\$145.34
4" x 2 1/2"	114.3 x 73.0mm	716AE42251	\$101.48	716AE42252	\$136.06
4" x 76.1mm	114.3 x 76.1mm	716ME42261	\$127.90	716ME42262	\$163.91
4" x 3"	114.3 x 88.9mm	716AE42301	\$95.05	716AE42302	\$125.00
139.7mm x 4"	139.7 x 114.3mm	716ME52421	\$128.33	716ME52422	\$171.32
5" x 4"	141.3 x 114.3mm	716AE53421	\$128.33	716AE53422	\$171.32
165.1 x 4"	165.1 x 114.3mm	716ME62421	\$194.55	716ME62422	\$248.59
6" x 4"	168.3 x 114.3mm	716AE63421	\$194.55	716AE63422	\$248.62
6" x 5"	168.3 x 141.3mm	716AE63531	\$170.23	716AE63532	\$223.81
8" x 6"	219.1 x 168.3mm	716AE80631	\$291.97	716AE80632	\$374.69

Notes

For price and availability for the couplings with Grade “T” Nitrile gaskets, contact GRINNELL Mechanical Products.

Orders for items in shaded areas **cannot** be cancelled or returned.

Technical Data Sheet: G120

All standard couplings can be provided with stainless steel nuts and bolts upon request.
 See latest catalog or technical data sheets for specific approvals, listings, and design parameters.
 POA = Price on availability. Prices subject to change without notice.

Introduction
 Couplings & Fittings
 Mechanical Tees
 Valves
 Circuit Balancing Valves
 Accessories
 Copper Systems
 Stainless Steel Systems
 Plain End Systems
 HDPE Systems
 G-MINE PVC Systems
 Gaskets & Spare Parts
 Preparation Equipment
 Miscellaneous
 Indexes

#702 Outlet Coupling
Grade “E” Gasket, Female Threaded End, Painted*

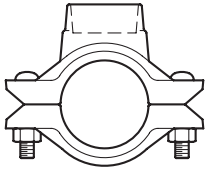
	Pipe Size		Painted	
	Nominal Size	Outside Diameter	Grade “E” EPDM	List Price
	1½" x ½"	48.3 x 21.3mm	7021505FES	\$97.50
	1½" x ¾"	48.3 x 26.7mm	7021575FES	\$97.50
	1½" x 1"	48.3 x 33.4mm	7021501FES	\$97.50
	2" x ½"	60.3 x 21.3mm	7022005FES	\$100.00
	2" x ¾"	60.3 x 26.7mm	7022075FES	\$100.00
	2" x 1"	60.3 x 33.4mm	7022001FES	\$100.00
	2½" x ½"	73.0 x 21.3mm	7022505FES	\$153.50
	2½" x ¾"	73.0 x 26.7mm	7022575FES	\$153.50
	2½" x 1"	73.0 x 33.4mm	7022501FES	\$153.50
	3" x ¾"	88.9 x 26.7mm	7023075FES	\$148.00
	3" x 1"	88.9 x 33.4mm	7023001FES	\$195.50
	4" x ¾"	114.3 x 26.7mm	7024075FES	\$217.00
	4" x 1"	114.3 x 33.4mm	7024001FES	\$217.00
	4" x 1½"	114.3 x 48.3mm	7024015FES	\$308.00
6" x 1"	168.3 x 33.4mm	7026001FES	\$435.00	
6" x 1½"	168.3 x 48.3mm	7026015FES	\$435.00	

Notes

* Galvanized available upon request.

 Orders for items in shaded areas **cannot** be cancelled or returned.

Technical Data Sheet: G220
#702 Outlet Coupling
Grade “E” Gasket, Male Threaded End, Painted*

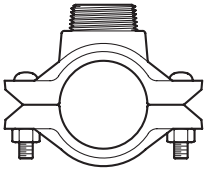
	Pipe Size		Painted	
	Nominal Size	Outside Diameter	Grade “E” EPDM	List Price
	2" x 1"	60.3 x 33.4mm	7022001MES	\$100.00
	2½" x 1¼"	73.0 x 42.4mm	7022513MES	\$173.00
	2½" x 1½"	73.0 x 48.3mm	7022515MES	\$195.50
	3" x 1"	88.9 x 33.4mm	7023001MES	\$195.50
	3" x 1½"	88.9 x 48.3mm	7023015MES	\$224.00
	4" x 1½"	114.3 x 48.3mm	7024015MES	\$308.00
	4" x 2"	114.3 x 60.3mm	7024020MES	\$308.00
	6" x 1½"	168.3 x 48.3mm	7026015MES	\$435.00
	6" x 2"	168.3 x 60.3mm	7026020MES	\$435.00

Notes

* Galvanized available upon request.

 Orders for items in shaded areas **cannot** be cancelled or returned.

Technical Data Sheet: G220

#702 Outlet Coupling
Grade "E" Gasket, Grooved End, Painted*

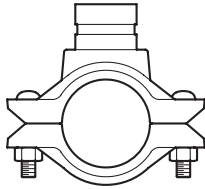

Pipe Size		Painted	
Nominal Size	Outside Diameter	Grade "E" EPDM	List Price
2" x 1"	60.3 x 33.4mm	7022001GRVES	\$100.00
2½" x 1¼"	73.0 x 42.4mm	7022513GRVES	\$173.00
2½" x 1½"	73.0 x 48.3mm	7022515GRVES	\$195.50
3" x 1"	88.9 x 33.4mm	7023001GRVES	\$195.50
3" x 1½"	88.9 x 48.3mm	7023015GRVES	\$224.00
4" x 1½"	114.3 x 48.3mm	7024015GRVES	\$308.00
4" x 2"	114.3 x 60.3mm	7024020GRVES	\$308.00
6" x 1½"	168.3 x 48.3mm	7026015GRVES	\$435.00
6" x 2"	168.3 x 60.3mm	7026020GRVES	\$435.00

Notes

* Galvanized available upon request.

Orders for items in shaded areas **cannot** be cancelled or returned.

Technical Data Sheet: G220

Introduction
 Couplings & Fittings
 Mechanical Tees
 Valves
 Circuit Balancing Valves
 Accessories
 Copper Systems
 Stainless Steel Systems
 Plain End Systems
 HDPE Systems
 G-MINE PVC Systems
 Gaskets & Spare Parts
 Preparation Equipment
 Miscellaneous
 Indexes

**#770 High Pressure Rigid Coupling
 with Grade “E” EPDM Gasket**

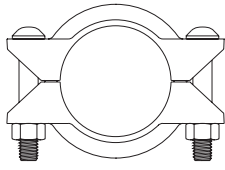
	Pipe Size		Painted		Galvanized	
	Nominal Size	Outside Diameter	Part Number	List Price	Part Number	List Price
	2"	60.3mm	770AE00601	\$45.18	770AE00602	\$61.75
	2½"	73.0mm	770AE00731	\$51.07	770AE00732	\$70.96
	3"	88.9mm	770AE00891	\$57.19	770AE00892	\$79.27
	4"	114.3mm	770AE01141	\$84.56	770AE01142	\$122.09
	6"	168.3mm	770AE01681	\$153.94	770AE01682	\$225.20
	8"	219.1mm	770AE02191	\$247.82	770AE02192	\$361.32
	10"	273.0mm	770AE02731	\$459.06	770AE02732	\$636.87
	12"	323.9mm	770AE03241	\$670.42	770AE03242	\$909.01

Notes

For price and availability for the #770 High Pressure Rigid Coupling with Grade “T” Nitrile standard gasket, Grade “E” EPDM or Grade “T” Nitrile Tri-Seal gasket, Grade “L” Silicone or Grade “O” Fluoroelastomer Gasket, contact GRINNELL Mechanical Products.

Orders for items in shaded areas *cannot* be cancelled or returned.

Technical Data Sheet: G138

**#780 Snap Coupling
 with Grade “E” EPDM Gasket**

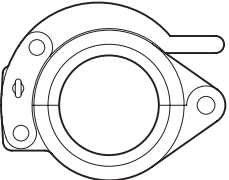
	Pipe Size		Painted		Galvanized	
	Nominal Size	Outside Diameter	Part Number	List Price	Part Number	List Price
	1½"	48.3mm	78015ES	\$77.48	78015GES	\$94.05
	2"	60.3mm	78020ES	\$82.00	78020GES	\$101.15
	2½"	73.0mm	78025ES	\$82.00	78025GES	\$101.15
	3"	88.9mm	78030ES	\$105.93	78030GES	\$128.08
	4"	114.3mm	78040ES	\$113.21	78040GES	\$147.80
	5"	141.3mm	78050ES	\$225.27	78050GES	\$289.42
	6"	168.3mm	78060ES	\$244.23	78060GES	\$312.93
	8"	219.1mm	78080ES	\$375.83	78080GES	\$477.45

Notes

For price and availability for the couplings with Grade “T” Nitrile gaskets, contact GRINNELL Mechanical Products.

Orders for items in shaded areas *cannot* be cancelled or returned.

Technical Data Sheet: G145

**#71 Grooved Flange Adapter ANSI 150 lbs.
 with Grade “E” EPDM Gasket**

	Pipe Size		Painted		Galvanized	
	Nominal Size	Outside Diameter	Part Number	List Price	Part Number	List Price
	2"	60.3mm	71AAE00601	\$121.70	71AAE00602	\$120.51
	2 1/2"	73.0mm	71AAE00731	\$116.17	71AAE00732	\$145.54
	3"	88.9mm	71AAE00891	\$114.86	71AAE00892	\$155.95
	4"	114.3mm	71AAE01141	\$123.40	71AAE01142	\$163.04
	5"	141.3mm	71AAE01411	\$165.96	71AAE01412	\$214.65
	6"	168.3mm	71AAE01681	\$152.99	71AAE01682	\$198.74
	8"	219.1mm	71AAE02191	\$217.12	71AAE02192	\$291.89
	10"	273.0mm	71AAE02731	\$367.19	71AAE02732	\$471.57
	12"	323.9mm	71AAE03241	\$590.99	71AAE03242	\$772.72
	14"	355.6mm	71AAE03551	\$939.40	71AAE03552	\$1,033.33
	16"	406.4mm	71AAE04061	\$1,128.68	71AAE04062	\$1,849.98
	18"	457.2mm	71AAE04571	\$1,355.36	71AAE04572	\$2,033.04
	20"	508.0mm	71AAE05081	\$1,714.52	71AAE05082	\$2,571.78
	24"	609.6mm	71AAE06091	\$2,952.04	71AAE06092	\$4,132.85

Notes

For price and availability for the couplings with Grade “T” Nitrile gaskets, contact GRINNELL Mechanical Products.

Orders for items in shaded areas *cannot* be cancelled or returned.

Technical Data Sheet: G150

**#71 Grooved Flange Adapter DN10/DN16
 with Grade “E” EPDM Gasket**

	Pipe Size		PN10/PN16	Painted		Galvanized	
	Nominal Size	Outside Diameter		Part Number	List Price	Part Number	List Price
	2"	60.3mm	PN10/PN16	71DAE00601	\$132.11	71DAE00602	\$154.10
	76.1mm	76.1mm	PN10/PN16	71DAE00761	\$145.60	71DAE00762	\$173.76
	3"	88.9mm	PN10/PN16	71DAE00891	\$115.93	71DAE00892	\$150.89
	4"	114.3mm	PN10/PN16	71DAE01141	\$118.43	71DAE01142	\$156.16
	139.7mm	139.7mm	PN10/PN16	71DME01391	\$150.42	71DME01392	\$195.30
	165.1mm	165.1mm	PN10/PN16	71DAE01651	\$152.99	71DAE01652	\$214.10
	6"	168.3mm	PN10/PN16	71DAE01681	\$150.42	71DAE01682	\$195.30
	8"	219.1mm	PN10	71DME82191	\$226.49	71DME82192	\$301.84
	8"	219.1mm	PN16	71DME02191	\$238.92	71DME02192	\$314.28
	10"	273.0mm	PN10	71DAE82731	\$338.66	71DAE82732	\$430.08
	10"	273.0mm	PN16	71DAE02731	\$369.74	71DAE02732	\$474.33
	12"	323.9mm	PN10	71DME83241	\$577.86	71DME83242	\$726.19
	12"	323.9mm	PN16	71DME03241	\$585.78	71DME03242	\$961.99

Note

For price and availability for the couplings with Grade “T” Nitrile gaskets, contact GRINNELL Mechanical Products.

Technical Data Sheet: G150

Introduction
 Couplings & Fittings
 Mechanical Tees
 Valves
 Circuit Balancing Valves
 Accessories
 Copper Systems
 Stainless Steel Systems
 Plain End Systems
 HDPE Systems
 G-MINE PVC Systems
 Gaskets & Spare Parts
 Preparation Equipment
 Miscellaneous
 Indexes

#210 and #310 Grooved 90° Elbow

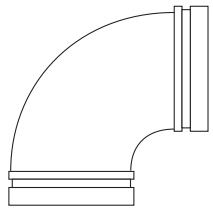
	Pipe Size		Painted		Galvanized	
	Nominal Size	Outside Diameter	Part Number	List Price	Part Number	List Price
	1" *	33.4mm	210M000341	\$28.83	210M000342	\$35.56
	1 ¹ / ₄ " *	42.4mm	210M000421	\$16.51	210M000422	\$21.16
	1 ¹ / ₂ " *	48.3mm	210M000481	\$18.41	210M000482	\$24.07
	2" *	60.3mm	210M000601	\$19.64	210M000602	\$24.12
	2 ¹ / ₂ " *	73.0mm	210M000731	\$28.21	210M000732	\$35.11
	76.1mm *	76.1mm	210M000761	\$28.21	210M000762	\$35.11
	3" *	88.9mm	210M000891	\$36.38	210M000892	\$43.08
	4" *	114.3mm	210M001141	\$50.94	210M001142	\$66.71
	139.7mm *	139.7mm	210M001391	\$122.52	210M001392	\$152.31
	5" *	141.3mm	210M001411	\$122.52	210M001412	\$152.31
	165.1mm *	165.1mm	210M001651	\$149.62	210M001652	\$194.03
	6" *	168.3mm	210M001681	\$149.62	210M001682	\$194.03
	8" *	219.1mm	210M002191	\$265.67	210M002192	\$363.92
	10" *	273.0mm	210M002731	\$529.72	210M002732	\$762.40
	12" *	323.9mm	210M003241	\$770.99	210M003242	\$1,031.49
	14"	355.6mm	–	POA	–	POA
	16"	406.4mm	–	POA	–	POA
	18"	457.2mm	–	POA	–	POA
	20"	508.0mm	–	POA	–	POA
	24"	609.6mm	–	POA	–	POA

Notes

Elbow is segmentally welded except where a * indicates it is available as a cast fitting.

 Orders for items in shaded areas *cannot* be cancelled or returned.

Technical Data Sheet: G180

#201 and #301 Grooved 45° Elbow

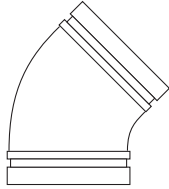

Pipe Size		Painted		Galvanized	
Nominal Size	Outside Diameter	Part Number	List Price	Part Number	List Price
1" *	33.4mm	201M000341	\$28.83	201M000342	\$35.56
1 1/4" *	42.4mm	201M000421	\$16.51	201M000422	\$21.16
1 1/2" *	48.3mm	201M000481	\$18.41	201M000482	\$24.07
2" *	60.3mm	201M000601	\$19.64	201M000602	\$24.12
2 1/2" *	73.0mm	201M000731	\$28.21	201M000732	\$35.11
76.1mm *	76.1mm	201M000761	\$28.21	201M000762	\$35.11
3" *	88.9mm	201M000891	\$36.38	201M000892	\$43.08
4" *	114.3mm	201M001141	\$50.94	201M001142	\$66.71
139.7mm *	139.7mm	201M001391	\$122.52	201M001392	\$152.31
5" *	141.3mm	201M001411	\$122.52	201M001412	\$152.31
165.1mm *	165.1mm	201M001651	\$149.62	201M001652	\$194.03
6" *	168.3mm	201M001681	\$149.62	201M001682	\$194.03
8" *	219.1mm	201M002191	\$265.67	201M002192	\$363.92
10" *	273.0mm	201M002731	\$440.73	201M002732	\$587.97
12" *	323.9mm	201M003241	\$533.01	201M003242	\$712.70
14"	355.6mm	–	POA	–	POA
16"	406.4mm	–	POA	–	POA
18"	457.2mm	75829	POA	73534	POA
20"	508.0mm	75830	POA	73535	POA
24"	609.6mm	75832	POA	73536	POA

Notes

Elbow is segmentally welded except where a * indicates it is available as a cast fitting.

Orders for items in shaded areas **cannot** be cancelled or returned.

Technical Data Sheet: G180

Introduction
 Couplings & Fittings
 Mechanical Tees
 Valves
 Circuit Balancing Valves
 Accessories
 Copper Systems
 Stainless Steel Systems
 Plain End Systems
 HDPE Systems
 G-MINE PVC Systems
 Gaskets & Spare Parts
 Preparation Equipment
 Miscellaneous
 Indexes

#212 and #312 – Grooved 22¹/₂° Elbow

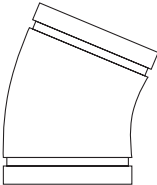
	Pipe Size		Painted		Galvanized	
	Nominal Size	Outside Diameter	Part Number	List Price	Part Number	List Price
	1 ¹ / ₄ " *	42.4mm	212A000421	\$83.88	212A000422	\$98.06
	1 ¹ / ₂ " *	48.3mm	212A000481	\$91.59	212A000482	\$107.39
	2" *	60.3mm	212A000601	\$35.43	212A000602	\$47.19
	2 ¹ / ₂ " *	73.0mm	212A000731	\$49.42	212A000732	\$64.80
	76.1mm *	76.1mm	212M000761	\$49.42	212M000762	\$64.80
	3" *	88.9mm	212A000891	\$72.32	212A000892	\$89.60
	4" *	114.3mm	212A001141	\$93.21	212A001142	\$122.73
	139.7mm *	139.7mm	212M001391	\$118.28	212M001392	\$149.65
	5" *	141.3mm	212A001411	\$301.41	212A001412	\$369.01
	6" *	168.3mm	212A001681	\$275.13	212A001682	\$355.74
	8" *	219.1mm	212A002191	\$576.42	212A002192	\$726.18
	10"	273.0mm	75559	\$791.13	75579	\$1,040.66
	12"	323.9mm	75560	\$1,069.77	75580	\$1,343.91
	14"	355.6mm	75561	\$1,273.50	75581	\$1,686.00
	16"	406.4mm	75562	\$1,527.00	75583	\$2,138.50
	18"	457.2mm	75563	\$1,849.00	75584	\$2,624.00
	20"	508.0mm	75564	\$2,321.50	75585	\$3,648.00
	24"	609.6mm	75565	\$3,961.00	75586	\$4,581.00

Notes

Elbow is segmentally welded except where a * indicates it is available as a cast fitting.

 Orders for items in shaded areas **cannot** be cancelled or returned.

Technical Data Sheet: G180

#211 and #311 – Grooved 11¹/₄° Elbow

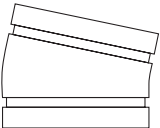
	Pipe Size		Painted		Galvanized	
	Nominal Size	Outside Diameter	Part Number	List Price	Part Number	List Price
	1 ¹ / ₄ " *	42.4mm	211A000421	\$83.88	211A000422	\$94.03
	1 ¹ / ₂ " *	48.3mm	211A000481	\$91.59	211A000482	\$113.75
	2" *	60.3mm	211A000601	\$35.55	211A000602	\$53.43
	2 ¹ / ₂ " *	73.0mm	211A000731	\$49.42	211A000732	\$64.80
	76.1mm *	76.1mm	211M000761	\$49.42	211M000762	\$64.80
	3" *	88.9mm	211A000891	\$72.32	211A000892	\$88.16
	4" *	114.3mm	211A001141	\$97.01	211A001142	\$116.87
	139.7mm *	139.7mm	211M001391	\$118.28	211M001392	\$149.65
	5" *	141.3mm	211A001411	\$301.41	211A001412	\$361.79
	165.1mm *	165.1mm	211M001651	\$275.13	211M001652	\$377.12
	6" *	168.3mm	211A001681	\$275.13	211A001682	\$377.12
	8" *	219.1mm	211A002191	\$491.96	211A002192	\$584.25
	10"	273.0mm	75309	\$738.21	75315	\$819.44
	12"	323.9mm	75310	\$1,069.77	75323	\$1,029.56
	14"	355.6mm	75311	\$1,152.00	75324	\$1,445.50
	16"	406.4mm	75312	\$1,418.50	75325	\$1,891.00
	18"	457.2mm	73537	\$1,717.50	75326	\$2,328.00
	20"	508.0mm	73538	\$2,102.00	75327	\$2,912.50
	24"	609.6mm	73539	\$3,668.00	75328	\$3,700.50

Notes

Elbow is segmentally welded except where a * indicates it is available as a cast fitting.

Orders for items in shaded areas *cannot* be cancelled or returned.

Technical Data Sheet: G180

Introduction
 Couplings & Fittings
 Mechanical Tees
 Valves
 Circuit Balancing Valves
 Accessories
 Copper Systems
 Stainless Steel Systems
 Plain End Systems
 HDPE Systems
 G-MINE PVC Systems
 Gaskets & Spare Parts
 Preparation Equipment
 Miscellaneous
 Indexes

#210LR and #310LR – Grooved 90° Long Radius Elbow

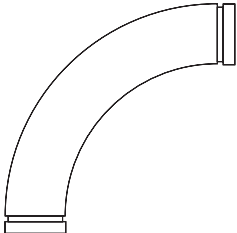
	Pipe Size		Painted		Galvanized	
	Nominal Size	Outside Diameter	Part Number	List Price	Part Number	List Price
	1 1/4"	42.4mm	73500	POA	73502	POA
	1 1/2"	48.3mm	73501	POA	73503	POA
	2" *	60.3mm	210LR00601	\$63.20	210LR00602	\$69.42
	2 1/2" *	73.0mm	210LR00731	\$158.77	210LR00732	\$214.00
	76.1mm *	76.1mm	210LR00761	\$158.77	210LR00762	\$214.00
	3" *	88.9mm	210LR00891	\$106.17	210LR00892	\$141.30
	4" *	114.3mm	210LR01141	\$159.27	210LR01142	\$216.34
	139.7mm *	139.7mm	210LR01391	\$293.26	219LR01392	\$1,290.50
	5" *	141.3mm	210LR01411	\$293.26	210LR01412	\$1,290.50
	165.1mm *	165.1mm	210LR01651	\$466.28	210LR01652	\$621.16
	6" *	168.3mm	210LR01681	\$466.28	210LR01682	\$621.16
	8" *	219.1mm	210LR02191	\$1,118.75	210LR02192	\$1,448.92
	10" *	273.0mm	210LR02731	\$1,855.91	210LR02732	\$2,411.40
	12" *	323.9mm	210LR03241	\$2,656.80	210LR03242	\$3,213.64
	14" *	355.6mm	210LR03551	\$2,837.86	210LR03552	\$3,764.85
	16" *	406.4mm	210LR04061	\$3,527.61	210LR04062	\$4,427.67
	18"	457.2mm	75790	\$4,723.65	73515	\$5,892.50
	20"	508.0mm	75826	\$6,226.85	73516	\$7,107.69
	24"	609.6mm	75827	\$9,017.54	73517	\$10,326.32

Notes

Elbow is segmentally welded except where a * indicates it is available as a cast fitting.

 Orders for items in shaded areas **cannot** be cancelled or returned.

Technical Data Sheet: G180

#201LR and #301LR – Grooved 45° Long Radius Elbow

	Pipe Size		Painted		Galvanized	
	Nominal Size	Outside Diameter	Part Number	List Price	Part Number	List Price
	1 1/4"	42.4mm	73518	POA	73521	POA
	1 1/2"	48.3mm	73519	POA	73522	POA
	2"	60.3mm	75791	\$53.93	73523	\$66.99
	2 1/2"	73.0mm	75792	\$192.20	73524	\$209.60
	3"	88.9mm	75793	\$92.18	73525	\$118.71
	4"	114.3mm	75794	\$112.43	73526	\$151.89
	5"	141.3mm	75795	\$514.28	73527	\$719.93
	6"	168.3mm	75796	\$335.02	73528	\$434.51
	8"	219.1mm	75797	\$582.24	73529	\$767.59
	10"	273.0mm	75798	\$1,157.99	73530	\$1,495.36
	12"	323.9mm	75799	\$1,821.02	73531	\$2,351.52
	14" *	355.6mm	201L14S	\$1,940.61	201L14GS	\$2,750.00
	16" *	406.4mm	201L16S	\$2,288.72	201L16GS	\$3,001.00
	18"	457.2mm	75829	\$2,682.69	73534	\$3,474.00
	20"	508.0mm	75830	\$3,722.50	73535	\$4,575.50
	24"	609.6mm	75832	\$5,413.73	73536	\$6,966.00

Notes

Elbow is segmentally welded except where a * indicates it is available as a cast fitting.

Orders for items in shaded areas *cannot* be cancelled or returned.

Technical Data Sheet: G180

Introduction
 Couplings & Fittings
 Mechanical Tees
 Valves
 Circuit Balancing Valves
 Accessories
 Copper Systems
 Stainless Steel Systems
 Plain End Systems
 HDPE Systems
 G-MINE PVC Systems
 Gaskets & Spare Parts
 Preparation Equipment
 Miscellaneous
 Indexes

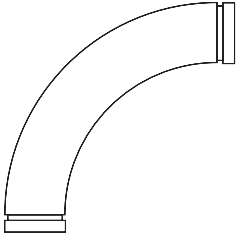

#310 - 3D, #310 - 5D, #310 - 6D Long Radius 90° Elbow, Painted

	Pipe Size		3D		5D		6D	
	Nominal Size	Outside Diameter	Part Number	List Price	Part Number	List Price	Part Number	List Price
	2"	60.3mm	310203D	\$1,078.00	310205D	\$1,157.00	310206D	\$1,187.00
	2½"	73.0mm	310253D	\$1,152.00	310255D	\$1,191.50	310256D	\$1,241.00
	3"	88.9mm	310303D	\$1,314.00	310305D	\$1,403.00	310306D	\$1,427.50
	4"	114.3mm	310403D	\$1,467.00	310405D	\$1,580.50	310406D	\$1,659.50
	5"	141.3mm	310503D	\$1,649.00	310505D	\$1,861.00	310506D	\$1,900.50
	6"	168.3mm	310603D	\$1,935.00	310605D	\$2,141.50	310606D	\$2,309.00
	8"	219.1mm	310803D	\$2,540.50	310805D	\$2,963.50	310806D	\$3,219.50
	10"	273.0mm	310103D	\$3,224.00	310105D	\$4,091.00	310106D	\$4,445.00
	12"	323.9mm	310123D	\$4,095.50	310125D	\$5,188.00	310126D	\$5,848.00
	14"	355.6mm	310143D	\$4,863.50	310145D	\$6,355.00	310146D	\$7,112.50
	16"	406.4mm	310163D	\$5,897.00	310165D	\$7,644.50	310166D	\$8,806.00
	18"	457.2mm	310183D	\$8,151.50	310185D	\$10,573.00	310186D	\$11,660.50
	20"	508.0mm	310213D	\$9,830.00	310215D	\$12,546.50	310216D	\$13,782.00
	24"	609.6mm	310243D	\$13,747.50	310245D	\$17,729.50	310246D	\$19,831.00

Notes

Elbow is segmentally welded.

Orders for items in shaded areas **cannot** be cancelled or returned.

#306 - 3D, #306 - 5D, #306 - 6D, Long Radius 60° Elbow, Painted

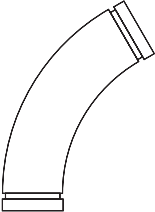
	Pipe Size		3D		5D		6D	
	Nominal Size	Outside Diameter	Part Number	List Price	Part Number	List Price	Part Number	List Price
	2"	60.3mm	306203D	\$1,043.50	306205D	\$1,098.00	306206D	\$1,118.00
	2½"	73.0mm	306253D	\$1,092.50	306255D	\$1,152.00	306256D	\$1,167.00
	3"	88.9mm	306303D	\$1,250.50	306305D	\$1,319.50	306306D	\$1,334.50
	4"	114.3mm	306403D	\$1,427.50	306405D	\$1,467.00	306406D	\$1,541.00
	5"	141.3mm	306503D	\$1,600.00	306505D	\$1,718.00	306506D	\$1,742.50
	6"	168.3mm	306603D	\$1,782.50	306605D	\$1,935.00	306606D	\$1,964.00
	8"	219.1mm	306803D	\$2,240.00	306805D	\$2,471.50	306806D	\$2,688.00
	10"	273.0mm	306103D	\$2,840.50	306105D	\$3,244.00	306106D	\$3,534.50
	12"	323.9mm	306123D	\$3,387.00	306125D	\$4,327.00	306126D	\$4,696.00
	14"	355.6mm	306143D	\$4,041.50	306145D	\$5,114.50	306146D	\$5,543.00
	16"	406.4mm	306163D	\$4,917.50	306165D	\$6,172.50	306166D	\$6,675.00
	18"	457.2mm	306183D	\$6,891.00	306185D	\$8,402.50	306186D	\$9,337.50
	20"	508.0mm	306213D	\$8,023.00	306215D	\$9,716.50	306216D	\$10,770.00
	24"	609.6mm	306243D	\$11,237.50	306245D	\$13,895.50	306246D	\$15,298.00

Notes

Elbow is segmentally welded.

Orders for items in shaded areas **cannot** be cancelled or returned.

#301 -3D, #301 - 5D, #301 -6D, Long Radius 45° Elbow, Painted

	Pipe Size		3D		5D		6D	
	Nominal Size	Outside Diameter	Part Number	List Price	Part Number	List Price	Part Number	List Price
	2"	60.3mm	301203D	\$1,024.00	301205D	\$1,053.50	301206D	\$1,068.50
	2½"	73.0mm	301253D	\$1,083.00	301255D	\$1,103.00	301256D	\$1,142.50
	3"	88.9mm	301303D	\$1,236.00	301305D	\$1,295.00	301306D	\$1,310.00
	4"	114.3mm	301403D	\$1,359.00	301405D	\$1,438.00	301406D	\$1,452.00
	5"	141.3mm	301503D	\$1,507.00	301505D	\$1,610.00	301506D	\$1,630.00
	6"	168.3mm	301603D	\$1,753.00	301605D	\$1,797.00	301606D	\$1,910.00
	8"	219.1mm	301803D	\$2,181.00	301805D	\$2,363.00	301806D	\$2,417.50
	10"	273.0mm	301103D	\$2,559.50	301105D	\$2,909.50	301106D	\$3,170.00
	12"	323.9mm	301123D	\$3,249.00	301125D	\$3,682.00	301126D	\$4,011.50
	14"	355.6mm	301143D	\$3,633.00	301145D	\$4,381.00	301146D	\$4,760.00
	16"	406.4mm	301163D	\$4,430.00	301165D	\$5,306.50	301166D	\$5,749.50
	18"	457.2mm	301183D	\$6,266.00	301185D	\$7,319.50	301186D	\$7,866.00
	20"	508.0mm	301213D	\$7,290.00	301215D	\$8,476.00	301216D	\$9,436.00
	24"	609.6mm	301243D	\$9,751.00	301245D	\$11,744.50	301246D	\$13,029.00

Notes
 Elbow is segmentally welded.
 Orders for items in shaded areas **cannot** be cancelled or returned.

#303 - 3D, #303 - 5D, #303 - 6D, Long Radius 30° Elbow, Painted

	Pipe Size		3D		5D		6D	
	Nominal Size	Outside Diameter	Part Number	List Price	Part Number	List Price	Part Number	List Price
	2"	60.3mm	303203D	\$1,004.50	303205D	\$1,024.00	303206D	\$1,034.00
	2½"	73.0mm	303253D	\$1,068.50	303255D	\$1,083.00	303256D	\$1,088.50
	3"	88.9mm	303303D	\$1,221.00	303305D	\$1,236.00	303306D	\$1,245.50
	4"	114.3mm	303403D	\$1,339.50	303405D	\$1,408.50	303406D	\$1,418.00
	5"	141.3mm	303503D	\$1,482.00	303505D	\$1,575.50	303506D	\$1,585.50
	6"	168.3mm	303603D	\$1,634.50	303605D	\$1,753.00	303606D	\$1,767.50
	8"	219.1mm	303803D	\$1,989.00	303805D	\$2,136.50	303806D	\$2,156.50
	10"	273.0mm	303103D	\$2,279.50	303105D	\$2,570.00	303106D	\$2,806.00
	12"	323.9mm	303123D	\$2,890.00	303125D	\$3,254.00	303126D	\$3,328.00
	14"	355.6mm	303143D	\$3,224.00	303145D	\$3,879.00	303146D	\$3,972.50
	16"	406.4mm	303163D	\$3,938.00	303165D	\$4,430.00	303166D	\$4,819.00
	18"	457.2mm	303183D	\$5,631.00	303185D	\$6,241.50	303186D	\$6,699.50
	20"	508.0mm	303213D	\$6,217.00	303215D	\$7,231.00	303216D	\$7,762.50
	24"	609.6mm	303243D	\$8,274.50	303245D	\$10,061.00	303246D	\$10,760.00

Notes
 Elbow is segmentally welded.
 Orders for items in shaded areas **cannot** be cancelled or returned.

Introduction
 Couplings & Fittings
 Mechanical Tees
 Valves
 Circuit/Balancing Valves
 Accessories
 Copper Systems
 Stainless Steel Systems
 Plain End Systems
 HDPE Systems
 G-MINE PVC Systems
 Gaskets & Spare Parts
 Preparation Equipment
 Miscellaneous
 Indexes



#312 3D, #312 - 5D, #312 - 6D, Long Radius 22¹/₂° Elbow, Painted

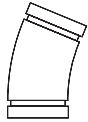

Pipe Size		3D		5D		6D	
Nominal Size	Outside Diameter	Part Number	List Price	Part Number	List Price	Part Number	List Price
2"	60.3mm	312203D	\$995.00	312205D	\$1,014.50	312206D	\$1,019.50
2 ¹ / ₂ "	73.0mm	312253D	\$1,064.00	312255D	\$1,073.50	312256D	\$1,078.50
3"	88.9mm	312303D	\$1,211.50	312305D	\$1,226.00	312306D	\$1,230.50
4"	114.3mm	312403D	\$1,329.00	312405D	\$1,344.00	312406D	\$1,354.00
5"	141.3mm	312503D	\$1,467.00	312505D	\$1,487.00	312506D	\$1,496.50
6"	168.3mm	312603D	\$1,619.50	312605D	\$1,639.50	312606D	\$1,742.50
8"	219.1mm	312803D	\$1,959.50	312805D	\$1,969.00	312806D	\$2,122.00
10"	273.0mm	312103D	\$2,250.00	312105D	\$2,491.00	312106D	\$2,530.50
12"	323.9mm	312123D	\$2,821.00	312125D	\$2,929.00	312126D	\$3,205.00
14"	355.6mm	312143D	POA	312145D	\$3,514.50	312146D	POA
16"	406.4mm	312163D	\$3,834.50	312165D	\$4,273.00	312166D	\$4,356.00
18"	457.2mm	312183D	\$5,163.50	312185D	\$5,695.50	312186D	\$6,123.50
20"	508.0mm	312213D	\$6,015.00	312215D	\$6,610.50	312216D	\$7,093.50
24"	609.6mm	312243D	\$7,989.00	312245D	\$8,756.50	312246D	\$9,396.50

Notes

Elbow is segmentally welded.

Orders for items in shaded areas **cannot** be cancelled or returned.

#311 - 3D, #311 - 5D, #311 - 6D, Long Radius 11¹/₄° Elbow, Painted

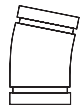

Pipe Size		3D		5D		6D	
Nominal Size	Outside Diameter	Part Number	List Price	Part Number	List Price	Part Number	List Price
2"	60.3mm	311203D	\$984.50	311205D	\$990.00	311206D	\$995.00
2 ¹ / ₂ "	73.0mm	311253D	\$1,053.50	311255D	\$1,058.50	311256D	\$1,058.50
3"	88.9mm	311303D	\$1,201.50	311305D	\$1,206.00	311306D	\$1,211.50
4"	114.3mm	311403D	\$1,314.50	311405D	\$1,319.50	311406D	\$1,324.50
5"	141.3mm	311503D	\$1,447.50	311505D	\$1,457.50	311506D	\$1,462.50
6"	168.3mm	311603D	\$1,595.00	311605D	\$1,605.00	311606D	\$1,615.00
8"	219.1mm	311803D	\$1,782.50	311805D	\$1,920.00	311806D	\$1,930.00
10"	273.0mm	311103D	\$2,028.50	311105D	\$2,225.50	311106D	\$2,235.00
12"	323.9mm	311123D	\$2,501.00	311125D	\$2,555.00	311126D	\$2,801.00
14"	355.6mm	311143D	\$2,771.50	311145D	\$3,076.50	311146D	\$3,111.50
16"	406.4mm	311163D	\$3,396.50	311165D	\$3,480.50	311166D	\$3,795.50
18"	457.2mm	311183D	\$4,617.50	311185D	\$5,035.50	311186D	\$5,094.50
20"	508.0mm	311213D	\$5,385.00	311215D	\$5,508.00	311216D	\$5,917.00
24"	609.6mm	311243D	\$7,107.50	311245D	\$7,255.50	311246D	\$7,812.00

Notes

Elbow is segmentally welded.

Orders for items in shaded areas **cannot** be cancelled or returned.

#316 Reducing Base Support Elbow, Groove x Flange

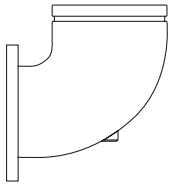
	Pipe Size		Painted		Galvanized	
	Nominal Size	Outside Diameter	Part Number	List Price	Part Number	List Price
	6" x 4"	168.3 x 114.3mm	72646	\$1,191.00	72670	POA
	6" x 5"	168.3 x 141.3mm	72647	\$1,348.50	72671	POA
	8" x 5"	219.1 x 141.3mm	72645	POA	72672	POA
	8" x 6"	219.1 x 168.3mm	72649	\$1,810.50	72673	POA
	10" x 6"	273.0 x 168.3mm	72650	POA	72674	POA
	10" x 8"	273.0 x 219.1mm	72651	\$2,711.50	72675	POA
	12" x 8"	323.9 x 219.1mm	72652	POA	72676	POA
	12" x 10"	323.9 x 273.0mm	72653	POA	72677	POA

Notes

Elbow is segmentally welded.

Orders for items in shaded areas **cannot** be cancelled or returned.

#315 Groove x Male Thread – Adapter 90° Elbow

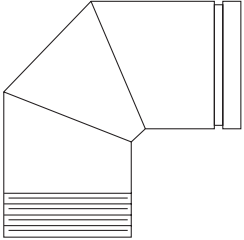
	Pipe Size		Painted		Galvanized	
	Nominal Size	Outside Diameter	Part Number	List Price	Part Number	List Price
	1 1/4"	42.4mm	75761	\$126.50	73540	\$140.50
	1 1/2"	48.3mm	75762	\$89.20	73541	\$187.50
	2"	60.3mm	75763	\$101.86	73542	\$120.43
	2 1/2"	73.0mm	75764	\$108.90	73543	\$128.86
	3"	88.9mm	75765	\$131.05	73544	\$158.45
	4"	114.3mm	75766	POA	73545	POA
	6"	168.3mm	75767	\$410.57	73546	\$456.10

Notes

Elbow is segmentally welded.

Orders for items in shaded areas **cannot** be cancelled or returned.

Technical Data Sheet: G180

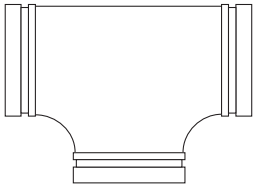
#219 and #319 – Grooved Tee

Pipe Size		Painted		Galvanized	
Nominal Size	Outside Diameter	Part Number	List Price	Part Number	List Price
1" *	33.4mm	219M000341	\$37.85	219M000342	\$49.74
1 1/4" *	42.4mm	219M000421	\$26.92	219M000422	\$31.91
1 1/2" *	48.3mm	219M000481	\$28.66	219M000482	\$33.56
2" *	60.3mm	219M000601	\$33.51	219M000602	\$42.40
2 1/2" *	73.0mm	219M000731	\$48.69	219M000732	\$59.58
76.1mm *	76.1mm	219M000761	\$48.69	219M000762	\$59.58
3" *	88.9mm	219M000891	\$64.01	219M000892	\$78.36
4" *	114.3mm	219M001141	\$86.83	219M001142	\$106.96
139.7mm *	139.7mm	219M001391	\$192.16	219M001392	\$236.99
5" *	141.3mm	219M001411	\$192.16	219M001412	\$236.99
165.1mm *	165.1mm	219M001651	\$207.48	219M001652	\$269.27
6" *	168.3mm	219M001681	\$207.48	219M001682	\$269.27
8" *	219.1mm	219M002191	\$555.33	219M002192	\$834.68
10" *	273.0mm	219M002731	\$906.11	219M002732	\$1,188.02
12" *	323.9mm	219M003241	\$1,263.26	219M003242	\$1,633.91
14" *	355.6mm	219M003551	\$2,139.75	219M003552	\$2,773.12
16" *	406.4mm	219M004061	\$2,739.21	219M004062	\$3,550.06
18"	457.2mm	73565	\$3,743.90	73570	\$4,887.27
20"	508.0mm	73566	\$5,365.03	73571	\$6,886.48
24"	609.6mm	73567	\$8,180.38	73572	\$10,742.37

Notes

Tee is segmentally welded except where a * indicates it is available as a cast fitting.

 Orders for items in shaded areas *cannot* be cancelled or returned.

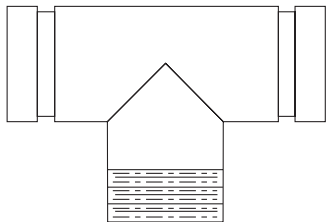
Technical Data Sheet: G180
#320 Groove x Male Thread – Tee

Pipe Size		Painted		Galvanized	
Nominal Size	Outside Diameter	Part Number	List Price	Part Number	List Price
1 1/4"	42.4mm	73547	\$213.00	73552	\$62.43
1 1/2"	48.3mm	75490	\$332.50	73553	\$62.43
2"	60.3mm	75491	\$105.14	73554	\$124.88
2 1/2"	73.0mm	75492	POA	73555	POA
3"	88.9mm	75493	POA	32030GS	POA
4"	114.3mm	75465	\$219.10	73557	\$267.54
5"	141.3mm	73548	\$498.23	73558	POA
6"	168.3mm	75466	\$1,133.50	73559	\$1,334.00
8"	219.1mm	73549	POA	73560	POA
10"	273.0mm	73550	POA	73561	POA
12"	323.9mm	73551	POA	73562	POA

Notes

Tee is segmentally welded.

 Orders for items in shaded areas *cannot* be cancelled or returned.

Technical Data Sheet: G180

#221 – Grooved Reducing Tee

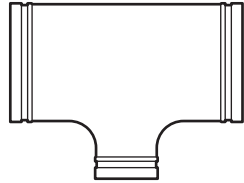

	Pipe Size		Painted		Galvanized	
	Nominal Size	Outside Diameter	Part Number	List Price	Part Number	List Price
	2" x 2" x 1 1/2"	60.3 x 60.3 x 48.3mm	221M020151	\$95.30	221M020152	\$102.04
	2 1/2" x 2 1/2" x 2"	73.0 x 73.0 x 60.3mm	221M025201	\$108.86	221M025202	\$136.49
	76.1mm x 76.1mm x 1 1/2"	76.1 x 76.1 x 48.3mm	221M026151	\$108.86	221M026152	\$136.51
	76.1mm x 76.1mm x 2"	76.1 x 76.1 x 60.3mm	221M026201	\$108.86	221M026202	\$136.51
	3" x 3" x 1"	88.9 x 88.9 x 33.4mm	221M030101	\$116.15	221M030102	\$146.47
	3" x 3" x 1 1/2"	88.9 x 88.9 x 48.3mm	221A030151	\$116.15	221A030152	\$146.47
	3" x 3" x 2"	88.9 x 88.9 x 60.3mm	221M030201	\$100.12	221M030202	\$125.35
	3" x 3" x 2 1/2"	88.9 x 88.9 x 73.0mm	221M030251	\$100.12	221M030252	\$125.35
	3" x 3" x 76.1mm	88.9 x 88.9 x 76.1mm	221M030261	\$94.90	221M030262	\$125.35
	4" x 4" x 2"	114.3 x 114.3 x 60.3mm	221M042201	\$158.03	221M042202	\$199.09
	4" x 4" x 2 1/2"	114.3 x 114.3 x 73.0mm	221M042251	\$136.26	221M042252	\$171.61
	4" x 4" x 76.1mm	114.3 x 114.3 x 76.1mm	221M042261	\$136.26	221M042262	\$171.61
	4" x 4" x 3"	114.3 x 114.3 x 88.9mm	221M042301	\$136.26	221M042302	\$171.61
	5" x 5" x 2 1/2"	141.3 x 141.3 x 73.0mm	221A053251	\$395.97	221A052252	\$446.54
	5" x 5" x 3"	141.3 x 141.3 x 88.9mm	221A053301	\$303.51	221A053302	\$384.96
	5" x 5" x 4"	141.3 x 141.3 x 114.3mm	221A053421	\$303.51	221A053422	\$384.96
	165.1mm x 165.1mm x 3"	165.1 x 165.1 x 88.9mm	221M062301	\$346.40	221M062302	\$462.30
	165.1mm x 165.1mm x 4"	165.1 x 165.1 x 114.3mm	221M062421	\$320.75	221M062422	\$398.53
	6" x 6" x 2"	168.3 x 168.3 x 60.3mm	221M063201	\$346.40	221M063202	\$462.30
	6" x 6" x 2 1/2"	168.3 x 168.3 x 73.0mm	221M063251	\$346.40	221M063252	\$462.30
	6" x 6" x 76.1mm	168.3 x 168.3 x 76.1mm	221M063261	\$346.40	221M063262	\$462.30
	6" x 6" x 3"	168.3 x 168.3 x 88.9mm	221M063301	\$346.40	221M063302	\$462.30
	6" x 6" x 4"	168.3 x 168.3 x 114.3mm	221M063421	\$320.75	221M063422	\$398.53
	8" x 8" x 4"	219.1 x 219.1 x 114.3mm	221M080521	\$983.45	221M080522	\$1,376.91
	8" x 8" x 6"	219.1 x 219.1 x 168.3mm	221M080601	\$910.62	221M080602	\$1,192.15
	10" x 10" x 4"	273.0 x 273.0 x 114.3mm	221M011421	\$1,063.28	221M011422	\$1,342.58
	10" x 10" x 6"	273.0 x 273.0 x 168.3mm	221M011631	\$1,003.09	221M011632	\$1,215.37
	10" x 10" x 8"	273.0 x 273.0 x 219.1mm	221M011801	\$1,003.09	221M011802	\$1,215.37

Note

Orders for items in shaded areas *cannot* be cancelled or returned.

Technical Data Sheet: G180

Introduction
 Couplings & Fittings
 Mechanical Tees
 Valves
 Circuit Balancing Valves
 Accessories
 Copper Systems
 Stainless Steel Systems
 Plain End Systems
 HDPE Systems
 G-MINE PVC Systems
 Gaskets & Spare Parts
 Preparation Equipment
 Miscellaneous
 Indexes

#321 – Grooved Reducing Tee

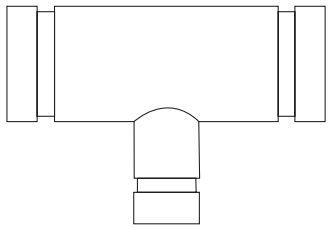
	Pipe Size		Painted		Galvanized	
	Nominal Size	Outside Diameter	Part Number	List Price	Part Number	List Price
	1 1/2" x 1 1/2" x 1 1/4"	48.3 x 48.3 x 42.4mm	73580	\$150.53	73589	\$148.16
	2" x 2" x 1"	60.3 x 60.3 x 33.4mm	75410	\$110.19	75470	\$115.74
	2 1/2" x 2 1/2" x 1"	73.0 x 73.0 x 33.4mm	75412	\$143.49	—	\$204.10
	2 1/2" x 2 1/2" x 1 1/4"	73.0 x 73.0 x 42.4mm	75413	\$143.49	73590	\$204.10
	2 1/2" x 2 1/2" x 1 1/2"	73.0 x 73.0 x 48.3mm	75414	\$108.86	73591	\$136.49
	4" x 4" x 1"	114.3 x 114.3 x 33.4mm	75420	\$158.03	—	\$199.09
	4" x 4" x 1 1/4"	114.3 x 114.3 x 42.4mm	73575	\$158.03	73593	\$199.09
	4" x 4" x 1 1/2"	114.3 x 114.3 x 48.3mm	75421	\$158.03	73594	\$199.09
	5" x 5" x 2"	141.3 x 141.3 x 60.3mm	75425	\$158.03	73595	\$199.09
	6" x 6" x 139.7mm	168.3 x 168.3 x 139.7mm	J75433	POA	—	\$398.53
	8" x 8" x 2"	219.1 x 219.1 x 60.3mm	73576	\$983.45	73599	\$1,376.91
	8" x 8" x 2 1/2"	219.1 x 219.1 x 73.0mm	73574	\$983.45	—	\$1,376.91
	8" x 8" x 3"	219.1 x 219.1 x 88.9mm	75435	\$983.45	75482	\$1,369.49
	8" x 8" x 5"	219.1 x 219.1 x 141.3mm	75437	\$910.62	75484	\$1,192.15
	10" x 10" x 2"	273.0 x 273.0 x 60.3mm	75461	\$1,063.28	73620	\$1,342.58
	10" x 10" x 3"	273.0 x 273.0 x 88.9mm	75439	\$1,063.28	73621	\$1,342.58
	10" x 10" x 4"	273.0 x 273.0 x 114.3mm	75440	\$1,063.28	73622	\$1,342.58
	10" x 10" x 5"	273.0 x 273.0 x 141.3mm	75441	\$1,063.28	73623	\$1,342.58
	10" x 10" x 6"	273.0 x 273.0 x 168.3mm	75442	\$1,003.09	73624	\$1,215.37
	10" x 10" x 8"	273.0 x 273.0 x 219.1mm	75443	\$1,003.09	73625	\$1,215.37
	12" x 12" x 3"	323.9 x 323.9 x 88.9mm	73615	\$1,535.90	73626	\$2,244.46
	12" x 12" x 4"	323.9 x 323.9 x 114.3mm	73577	\$1,535.90	73627	\$2,244.46
	12" x 12" x 5"	323.9 x 323.9 x 141.3mm	73578	\$1,535.90	73628	\$2,244.46
	12" x 12" x 6"	323.9 x 323.9 x 168.3mm	75444	\$1,535.90	73629	\$2,244.46
	12" x 12" x 8"	323.9 x 323.9 x 219.1mm	75445	\$1,448.92	73630	\$1,955.27
	12" x 12" x 10"	323.9 x 323.9 x 273.0mm	75446	\$1,448.92	73631	\$1,955.27
	14" x 14" x 6"	355.6 x 355.6 x 168.3mm	75447	\$1,768.58	73632	\$2,338.65
	14" x 14" x 8"	355.6 x 355.6 x 219.1mm	73579	\$1,768.58	73633	\$2,338.65
14" x 14" x 10"	355.6 x 355.6 x 273.0mm	75448	\$1,668.45	73634	\$2,166.23	
14" x 14" x 12"	355.6 x 355.6 x 323.9mm	75449	\$1,668.45	75486	\$2,166.23	

#321 – Grooved Reducing Tee

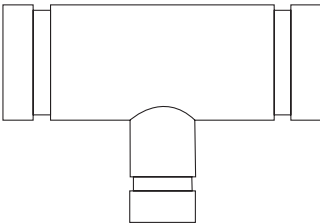
	Pipe Size		Painted		Galvanized	
	Nominal Size	Outside Diameter	Part Number	List Price	Part Number	List Price
 <p>(Continued from previous page)</p>	16" x 16" x 4"	406.4 x 406.4 x 114.3mm	75454	POA	73635	POA
	16" x 16" x 8"	406.4 x 406.4 x 219.1mm	75450	\$2,315.41	73636	\$2,962.91
	16" x 16" x 10"	406.4 x 406.4 x 273.0mm	J75451	\$2,315.41	73637	\$2,962.91
	16" x 16" x 12"	406.4 x 406.4 x 323.9mm	J75452	\$2,188.51	75469	\$2,743.39
	16" x 16" x 14"	406.4 x 406.4 x 355.6mm	75453	\$2,188.51	73638	\$2,743.39
	18" x 18" x 8"	457.2 x 457.2 x 219.1mm	75455	\$3,121.48	73639	\$4,440.61
	18" x 18" x 10"	457.2 x 457.2 x 273.0mm	75456	\$2,992.01	73640	\$4,327.60
	18" x 18" x 12"	457.2 x 457.2 x 323.9mm	75457	\$2,992.01	73641	\$4,327.60
	18" x 18" x 14"	457.2 x 457.2 x 355.6mm	75458	\$2,440.05	73642	\$4,635.00
	18" x 18" x 16"	457.2 x 457.2 x 406.4mm	75459	\$2,950.34	73643	\$4,969.50
	20" x 20" x 14"	508.0 x 508.0 x 355.6mm	73581	\$4,808.19	73644	\$6,109.00
	20" x 20" x 16"	508.0 x 508.0 x 406.4mm	73582	\$4,544.58	73645	\$4,999.04
	20" x 20" x 18"	508.0 x 508.0 x 457.2mm	73583	\$4,544.58	73646	\$4,999.04
	24" x 24" x 10"	609.6 x 609.6 x 273.0mm	73584	\$5,975.30	73647	\$7,864.50
	24" x 24" x 12"	609.6 x 609.6 x 323.9mm	73585	\$5,975.30	73648	\$7,864.50
	24" x 24" x 14"	609.6 x 609.6 x 355.6mm	73586	\$5,975.30	73649	\$7,864.50
	24" x 24" x 16"	609.6 x 609.6 x 406.4mm	73587	\$5,975.30	73650	\$7,864.50
	24" x 24" x 18"	609.6 x 609.6 x 457.2mm	75460	\$5,648.35	73651	\$7,864.50
	24" x 24" x 20"	609.6 x 609.6 x 508.0mm	73588	\$5,648.35	73652	\$7,864.50
	Notes					
Tee is segmentally welded						
Orders for items in shaded areas <i>cannot</i> be cancelled or returned.						
Technical Data Sheet: G180						

Introduction

Couplings & Fittings

Mechanical Tees

Valves

Circuit Balancing Valves

Accessories

Copper Systems

Stainless Steel Systems

Plain End Systems

HDPE Systems

G-MINE PVC Systems

Gaskets & Spare Parts

Preparation Equipment

Miscellaneous

Indexes

#323 Groove x Male Thread – Reducing Tee with Threaded Branch

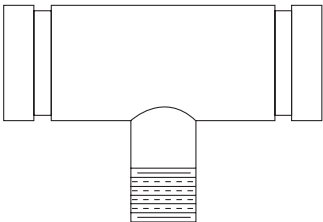
	Pipe Size		Painted		Galvanized	
	Nominal Size	Outside Diameter	Part Number	List Price	Part Number	List Price
	1 1/2" x 1 1/2" x 1 1/4"	48.3 x 48.3 x 42.4mm	73653	POA	73868	POA
	2" x 2" x 1"	60.3 x 60.3 x 33.4mm	75500	\$83.92	75520	\$103.99
	2" x 2" x 1 1/4"	60.3 x 60.3 x 42.4mm	75409	\$155.62	—	\$193.31
	2" x 2" x 1 1/2"	60.3 x 60.3 x 48.3mm	75501	\$83.92	75522	\$96.33
	2 1/2" x 2 1/2" x 1"	73.0 x 73.0 x 33.4mm	76502	\$163.35	75408	\$197.78
	2 1/2" x 2 1/2" x 1 1/4"	73.0 x 73.0 x 42.4mm	75502	\$163.35	73608	\$197.78
	2 1/2" x 2 1/2" x 1 1/2"	73.0 x 73.0 x 48.3mm	75503	\$163.35	73609	\$183.12
	2 1/2" x 2 1/2" x 2"	73.0 x 73.0 x 60.3mm	75504	\$163.35	73610	\$179.68
	3" x 3" x 1"	88.9 x 88.9 x 33.4mm	75505	\$163.35	75521	\$208.50
	3" x 3" x 1 1/2"	88.9 x 88.9 x 48.3mm	75506	\$163.35	75546	\$208.50
	3" x 3" x 2"	88.9 x 88.9 x 60.3mm	75507	\$163.35	75523	\$208.50
	3" x 3" x 2 1/2"	88.9 x 88.9 x 73.0mm	75508	\$277.37	73611	\$310.30
	4" x 4" x 1"	114.3 x 114.3 x 33.4mm	75509	\$204.12	75524	\$256.19
	4" x 4" x 1 1/4"	114.3 x 114.3 x 42.4mm	76541	\$220.14	—	\$344.75
	4" x 4" x 1 1/2"	114.3 x 114.3 x 48.3mm	75541	\$293.98	76524	\$344.75
	4" x 4" x 2"	114.3 x 114.3 x 60.3mm	75510	\$204.12	75525	\$259.51
	4" x 4" x 2 1/2"	114.3 x 114.3 x 73.0mm	75511	\$204.12	73691	\$247.57
	4" x 4" x 3"	114.3 x 114.3 x 88.9mm	75512	\$204.12	75526	\$248.72
	5" x 5" x 2"	141.3 x 141.3 x 60.3mm	75513	\$335.56	75534	\$662.50
	5" x 5" x 2 1/2"	141.3 x 141.3 x 73.0mm	76822	\$546.50	—	\$692.00
	5" x 5" x 3"	141.3 x 141.3 x 88.9mm	73654	\$505.50	75535	\$636.50
	5" x 5" x 4"	141.3 x 141.3 x 114.3mm	73655	\$546.50	73693	\$744.50
	6" x 6" x 2"	168.3 x 168.3 x 60.3mm	75514	\$513.61	75527	\$618.32
	6" x 6" x 2 1/2"	168.3 x 168.3 x 73.0mm	75590	\$443.01	75528	\$667.83
	6" x 6" x 3"	168.3 x 168.3 x 88.9mm	75515	\$513.61	75529	\$618.32
	6" x 6" x 4"	168.3 x 168.3 x 114.3mm	75516	\$513.61	73694	\$618.32
	6" x 6" x 5"	168.3 x 168.3 x 141.3mm	75517	\$709.00	73695	\$883.50
	8" x 8" x 2"	219.1 x 219.1 x 60.3mm	75518	\$629.81	73696	\$760.43
	8" x 8" x 3"	219.1 x 219.1 x 88.9mm	75519	\$629.81	73697	\$821.26
	8" x 8" x 4"	219.1 x 219.1 x 114.3mm	73656	\$893.55	73698	\$1,186.43
8" x 8" x 5"	219.1 x 219.1 x 141.3mm	73657	\$954.67	73699	\$1,336.53	
8" x 8" x 6"	219.1 x 219.1 x 168.3mm	73658	\$893.55	J73700	\$1,250.97	
10" x 10" x 2"	273.0 x 273.0 x 60.3mm	73659	\$1,126.80	J73701	\$1,480.40	
10" x 10" x 3"	273.0 x 273.0 x 88.9mm	73660	\$1,126.80	J73702	\$1,370.73	
10" x 10" x 4"	273.0 x 273.0 x 114.3mm	73661	\$1,126.80	J73703	\$1,370.73	
10" x 10" x 5"	273.0 x 273.0 x 141.3mm	73662	\$1,389.50	J73704	\$2,062.50	
10" x 10" x 6"	273.0 x 273.0 x 168.3mm	73663	\$1,615.50	J73705	\$2,089.00	
10" x 10" x 8"	273.0 x 273.0 x 219.1mm	73664	\$2,179.00	J73706	\$2,436.00	

#323 Groove x Male Thread – Reducing Tee with Threaded Branch

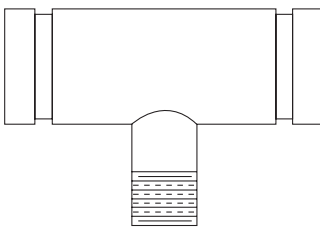
	Pipe Size		Painted		Galvanized	
	Nominal Size	Outside Diameter	Part Number	List Price	Part Number	List Price
 (Continued from previous page)	12" x 12" x 3"	323.9 x 323.9 x 88.9mm	73665	\$1,662.92	73707	\$1,898.74
	12" x 12" x 4"	323.9 x 323.9 x 114.3mm	73666	\$2,180.50	73708	\$2,800.50
	12" x 12" x 5"	323.9 x 323.9 x 141.3mm	73667	\$2,305.50	73709	\$2,994.50
	12" x 12" x 6"	323.9 x 323.9 x 168.3mm	73668	\$2,333.50	73710	\$3,022.50
	12" x 12" x 8"	323.9 x 323.9 x 219.1mm	73669	\$2,398.50	73711	\$3,092.50
	12" x 12" x 10"	323.9 x 323.9 x 273.0mm	73670	\$2,510.00	J73712	\$3,097.00
	14" x 14" x 6"	355.6 x 355.6 x 168.3mm	73671	POA	J73713	POA
	14" x 14" x 8"	355.6 x 355.6 x 219.1mm	73672	POA	J73714	POA
	14" x 14" x 10"	355.6 x 355.6 x 273.0mm	73673	POA	J73715	POA
	14" x 14" x 12"	355.6 x 355.6 x 323.9mm	73674	POA	J73716	POA
	16" x 16" x 4"	406.4 x 406.4 x 114.3mm	—	POA	—	POA
	16" x 16" x 8"	406.4 x 406.4 x 219.1mm	73675	POA	J73717	POA
	16" x 16" x 10"	406.4 x 406.4 x 273.0mm	73676	POA	J73718	POA
	16" x 16" x 12"	406.4 x 406.4 x 323.9mm	73677	POA	J73719	POA
	16" x 16" x 14"	406.4 x 406.4 x 355.6mm	—	POA	—	POA
	18" x 18" x 8"	457.2 x 457.2 x 219.1mm	73678	POA	J73720	POA
	18" x 18" x 10"	457.2 x 457.2 x 273.0mm	73679	POA	J73721	POA
	18" x 18" x 12"	457.2 x 457.2 x 323.9mm	73680	POA	J73722	POA
	18" x 18" x 14"	457.2 x 457.2 x 355.6mm	73681	POA	J73723	POA
	18" x 18" x 16"	457.2 x 457.2 x 406.4mm	73682	POA	73724	POA
	20" x 20" x 14"	508.0 x 508.0 x 355.6mm	—	POA	—	POA
	20" x 20" x 16"	508.0 x 508.0 x 406.4mm	—	POA	—	POA
	20" x 20" x 18"	508.0 x 508.0 x 457.2mm	—	POA	—	POA
	24" x 24" x 8"	609.6 x 609.6 x 219.1mm	73683	POA	73725	POA
24" x 24" x 10"	609.6 x 609.6 x 273.0mm	73684	POA	73726	POA	
24" x 24" x 12"	609.6 x 609.6 x 323.9mm	73685	POA	73727	POA	
24" x 24" x 14"	609.6 x 609.6 x 355.6mm	—	POA	—	POA	
24" x 24" x 16"	609.6 x 609.6 x 406.4mm	—	POA	—	POA	
24" x 24" x 18"	609.6 x 609.6 x 457.2mm	—	POA	—	POA	
Notes						
Tee is segmentally welded.						
Orders for items in shaded areas cannot be cancelled or returned.						
Technical Data Sheet: G180						

Introduction
 Couplings & Fittings
 Mechanical Tees
 Valves
 Circuit Balancing Valves
 Accessories
 Copper Systems
 Stainless Steel Systems
 Plain End Systems
 HDPE Systems
 G-MINE PVC Systems
 Gaskets & Spare Parts
 Preparation Equipment
 Miscellaneous
 Indexes

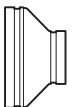

#250 – Grooved Concentric Reducer

	Pipe Size		Painted		Galvanized	
	Nominal Size	Outside Diameter	Part Number	List Price	Part Number	List Price
	1 1/4" x 1"	42.4 x 33.4mm	250M012101	\$49.95	250M012102	\$55.48
	1 1/2" x 1"	48.3 x 33.4mm	250M015101	\$48.69	250M015102	\$55.48
	1 1/2" x 1 1/4"	48.3 x 42.4mm	2501513S	\$48.69	2501513GS	\$55.48
	2" x 1"	60.3 x 33.4mm	250M020101	\$58.07	250M020102	\$72.82
	2" x 1 1/4"	60.3 x 42.4mm	250M020121	\$48.69	250M020122	\$60.69
	2" x 1 1/2"	60.3 x 48.3mm	250M020151	\$48.69	250M020152	\$60.69
	2 1/2" x 1 1/4"	73.0 x 42.4mm	2502513S	\$281.90	2502513GS	\$68.04
	2 1/2" x 1 1/2"	73.0 x 48.3mm	2502515S	\$59.15	2502515GS	\$63.91
	2 1/2" x 2"	73.0 x 60.3mm	250M025201	\$59.15	250M025202	\$63.91
	3" x 1 1/2"	88.9 x 48.3mm	250A030151	\$61.86	250A030152	\$76.52
	3" x 2"	88.9 x 60.3mm	250M030201	\$56.19	250M030202	\$70.85
	3" x 2 1/2"	88.9 x 73.0mm	250M030251	\$56.19	250M030252	\$70.85
	3" x 76.1mm	88.9 x 76.1mm	250M030261	\$56.19	250M030262	\$70.85
	4" x 2"	114.3 x 60.3mm	250M042201	\$60.82	250M042202	\$75.74
	4" x 2 1/2"	114.3 x 73.0mm	250M042251	\$56.34	250M042252	\$66.76
	4" x 76.1mm	114.3 x 76.1mm	250M042261	\$56.34	250M042262	\$66.76
	4" x 3"	114.3 x 88.9mm	250M042301	\$56.34	250M042302	\$66.76
	5" x 3"	141.3 x 88.9mm	2505030S	\$145.38	2505030GS	\$149.97
	5" x 4"	141.3 x 114.3mm	250M053421	\$145.38	250M053422	\$149.97
	6" x 2"	168.3 x 60.3mm	250M063201	\$138.27	250M063202	\$152.36
	6" x 2 1/2"	168.3 x 73.0mm	2506025S	\$138.27	2506025GS	\$152.36
	6" x 76.1mm	168.3 x 76.1mm	250M063261	POA	250M063262	\$599.04
	6" x 3"	168.3 x 88.9mm	250A063301	\$138.27	250A063302	\$152.36
	6" x 4"	168.3 x 114.3mm	250M063421	\$128.04	250M063422	\$141.86
	6" x 5"	168.3 x 141.3mm	250M063531	\$128.04	250M063532	\$141.86
	8" x 3"	219.1 x 88.9mm	250A080301	\$304.43	250A080302	\$345.38
	8" x 4"	219.1 x 114.3mm	250A080421	\$304.43	250A080422	\$345.38
	8" x 5"	219.1 x 141.3mm	250A080531	\$281.87	250A080532	\$325.83
8" x 6"	219.1 x 168.3mm	250A080631	\$281.87	250A080632	\$325.83	
10" x 6"	273.0 x 168.3mm	250A011631	\$468.54	250A011632	\$566.72	
10" x 8"	273.0 x 219.1mm	250A011801	\$468.54	250A011802	\$566.72	
12" x 4"	323.9 x 114.3mm	250A013421	\$655.38	250A013422	\$721.41	
12" x 6"	323.9 x 168.3mm	250A013631	\$655.38	250A013632	\$721.41	
12" x 8"	323.9 x 219.1mm	250A013801	\$606.83	250A013802	\$667.94	
12" x 10"	323.9 x 273.0mm	250A013111	\$606.83	250A013112	\$667.94	

Note

Orders for items in shaded areas *cannot* be cancelled or returned.

Technical Data Sheet: G180

#350 – Grooved Concentric Reducer

	Pipe Size		Painted		Galvanized	
	Nominal Size	Outside Diameter	Part Number	List Price	Part Number	List Price
	3" x 1"	88.9 x 33.4mm	72860	\$61.86	73406	\$76.52
	3" x 1 1/4"	88.9 x 42.4mm	72861	\$61.86	73396	\$76.52
	4" x 1 1/4"	114.3 x 42.4mm	72868	POA	73756	POA
	4" x 1 1/2"	114.3 x 48.3mm	72869	\$57.64	73410	\$75.74
	5" x 1 1/2"	141.3 x 48.3mm	73747	POA	73757	POA
	5" x 2"	141.3 x 60.3mm	72876	\$587.29	73399	\$633.17
	5" x 2 1/2"	141.3 x 73.0mm	72877	\$587.29	73758	POA
	8" x 2"	219.1 x 60.3mm	73748	POA	73760	POA
	8" x 2 1/2"	219.1 x 73.0mm	73749	POA	73761	POA
	10" x 4"	273.0 x 114.3mm	73764	\$506.00	73764	\$600.73
	10" x 5"	273.0 x 141.3mm	73750	\$506.00	73765	\$2037.34
	14" x 6"	355.6 x 168.3mm	72897	POA	73768	POA
	14" x 8"	355.6 x 219.1mm	72898	\$2,698.50	73769	\$2,985.50
	14" x 10"	355.6 x 273.0mm	72899	\$2,048.23	73770	\$2,543.93
	14" x 12"	355.6 x 323.9mm	72900	\$2,048.23	73771	\$2,543.93
	16" x 8"	406.4 x 219.1mm	72901	POA	73772	POA
	16" x 10"	406.4 x 273.0mm	72902	POA	73773	POA
	16" x 12"	406.4 x 323.9mm	72903	\$2,793.01	73774	\$3,469.01
	16" x 14"	406.4 x 355.6mm	72904	\$2,793.01	73775	\$3,469.01
	18" x 12"	457.2 x 323.9mm	72906	POA	73776	POA
	18" x 14"	457.2 x 355.6mm	72910	\$3,537.88	73777	\$4,394.11
	18" x 16"	457.2 x 406.4mm	72911	\$3,537.88	73778	\$4,394.11
	20" x 10"	508.0 x 273.0mm	73751	POA	73779	POA
	20" x 12"	508.0 x 323.9mm	72915	POA	73780	POA
	20" x 14"	508.0 x 355.6mm	73752	POA	73781	POA
	20" x 16"	508.0 x 406.4mm	73753	\$3,724.04	73782	\$4,625.30
	20" x 18"	508.0 x 457.2mm	73754	\$3,724.04	73783	\$4,625.30
	24" x 10"	609.6 x 273.0mm	72920	POA	73784	POA
24" x 12"	609.6 x 323.9mm	72921	POA	73785	POA	
24" x 14"	609.6 x 355.6mm	72922	POA	73786	POA	
24" x 16"	609.6 x 406.4mm	72923	POA	J73787	POA	
24" x 18"	609.6 x 457.2mm	72924	\$8,379.27	73788	\$9,310.30	
24" x 20"	609.6 x 508.0mm	72925	\$8,379.27	73789	\$9,310.30	

Notes

Reducer is segmentally welded.

Orders for items in shaded areas **cannot** be cancelled or returned.

Technical Data Sheet: G180

Introduction
 Couplings & Fittings
 Mechanical Tees
 Valves
 Circuit Balancing Valves
 Accessories
 Copper Systems
 Stainless Steel Systems
 Plain End Systems
 HDPE Systems
 G-MINE PVC Systems
 Gaskets & Spare Parts
 Preparation Equipment
 Miscellaneous
 Indexes

#251 – Grooved Eccentric Reducer

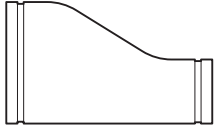
	Pipe Size		Painted		Galvanized	
	Nominal Size	Outside Diameter	Part Number	List Price	Part Number	List Price
	3" x 2"	88.9 x 60.3mm	251A030201	\$104.30	251A030202	\$114.12
	3" x 2 1/2"	88.9 x 73.0mm	251A030251	\$104.30	251A030252	\$114.12
	4" x 2"	114.3 x 60.3mm	251A042201	\$119.79	251A042202	\$131.32
	4" x 2 1/2"	114.3 x 73.0mm	251A042251	\$110.91	251A042252	\$121.64
	4" x 3"	114.3 x 88.9mm	251A042301	\$110.91	251A042302	\$121.64
	5" x 4"	141.3 x 114.3mm	251A053421	\$156.33	251A053422	\$170.64
	6" x 3"	168.3 x 88.9mm	251A063301	\$171.96	251A063302	\$184.50
	6" x 4"	168.3 x 114.3mm	251A063421	\$159.22	251A063422	\$174.10
	6" x 5"	168.3 x 141.3mm	251A063531	\$159.22	251A063532	\$174.10
Note						
Orders for items in shaded areas <i>cannot</i> be cancelled or returned.						
Technical Data Sheet: G180						

#351 – Grooved Eccentric Reducer

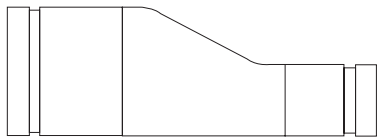
	Pipe Size		Painted		Galvanized	
	Nominal Size	Outside Diameter	Part Number	List Price	Part Number	List Price
	1 1/2" x 1 1/4"	48.3 x 42.4mm	73812	\$134.90	73845	POA
	2" x 1"	60.3 x 33.4mm	73815	\$196.60	—	\$207.58
	2" x 1 1/4"	60.3 x 42.4mm	73813	\$159.29	73846	\$192.22
	2" x 1 1/2"	60.3 x 48.3mm	72930	\$159.29	73847	\$192.22
	2 1/2" x 1 1/4"	73.0 x 42.4mm	72931	\$185.00	73848	\$202.00
	2 1/2" x 1 1/2"	73.0 x 48.3mm	72932	\$206.10	73850	\$219.63
	2 1/2" x 2"	73.0 x 60.3mm	72933	\$206.10	73851	\$219.63
	3" x 1 1/4"	88.9 x 42.4mm	73814	\$297.46	73852	POA
	3" x 1 1/2"	88.9 x 48.3mm	76587	\$297.46	73853	\$474.59
	4" x 1 1/4"	114.3 x 42.4mm	73817	POA	73855	POA
	4" x 1 1/2"	114.3 x 48.3mm	73816	\$119.79	73856	\$131.32
	5" x 2"	141.3 x 60.3mm	J73818	\$1,507.65	73860	POA
	5" x 2 1/2"	141.3 x 73.0mm	73819	\$719.38	73861	POA
	5" x 3"	141.3 x 88.9mm	72939	\$156.33	73862	\$170.64
	6" x 2"	168.3 x 60.3mm	73820	\$469.88	72963	\$499.51
	6" x 2 1/2"	168.3 x 73.0mm	72941	\$171.96	73864	\$184.50
8" x 3"	219.1 x 88.9mm	72946	\$1,418.57	73868	\$1,560.44	
8" x 4"	219.1 x 114.3mm	72947	\$1,418.57	73869	\$1,560.44	
8" x 5"	219.1 x 141.3mm	72948	\$310.10	73870	\$343.99	
8" x 6"	219.1 x 168.3mm	72949	\$310.10	73871	\$343.99	

#351 – Grooved Eccentric Reducer

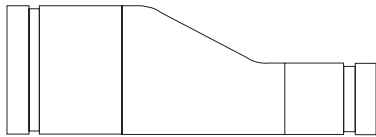
	Pipe Size		Painted		Galvanized	
	Nominal Size	Outside Diameter	Part Number	List Price	Part Number	List Price
 (Continued from previous page)	10" x 4"	273.0 x 114.3mm	72950	\$1,668.83	73872	\$2,081.11
	10" x 5"	273.0 x 141.3mm	73821	\$1,668.83	73873	POA
	10" x 6"	273.0 x 168.3mm	72951	\$1,574.36	73874	\$1,963.34
	10" x 8"	273.0 x 219.1mm	72952	\$1,574.36	73875	\$1,963.34
	12" x 4"	323.9 x 114.3mm	73822	\$2,531.29	73876	POA
	12" x 6"	323.9 x 168.3mm	73823	\$2,531.29	73877	\$2,789.14
	12" x 8"	323.9 x 219.1mm	72953	\$2,117.85	73878	\$2,631.28
	12" x 10"	323.9 x 273.0mm	72954	\$2,117.85	73879	\$2,631.28
	14" x 6"	355.6 x 168.3mm	73824	POA	73880	POA
	14" x 8"	355.6 x 219.1mm	72955	POA	73881	POA
	14" x 10"	355.6 x 273.0mm	73825	\$3,202.55	73882	POA
	14" x 12"	355.6 x 323.9mm	72956	\$3,069.73	73883	POA
	16" x 8"	406.4 x 219.1mm	73827	POA	73884	POA
	16" x 10"	406.4 x 273.0mm	73828	POA	73885	POA
	16" x 12"	406.4 x 323.9mm	72958	POA	73886	POA
	16" x 14"	406.4 x 355.6mm	73830	POA	73887	POA
	18" x 12"	457.2 x 323.9mm	73831	POA	73888	POA
	18" x 14"	457.2 x 355.6mm	73832	POA	73889	POA
	18" x 16"	457.2 x 406.4mm	73833	POA	73890	POA
	20" x 10"	508.0 x 273.0mm	73751	POA	73891	POA
	20" x 12"	508.0 x 323.9mm	72915	POA	73892	POA
	20" x 14"	508.0 x 355.6mm	73752	POA	73893	POA
	20" x 16"	508.0 x 406.4mm	73753	\$7,081.79	73894	POA
	20" x 18"	508.0 x 457.2mm	73754	POA	73895	POA
24" x 10"	609.6 x 273.0mm	72920	POA	73896	POA	
24" x 12"	609.6 x 323.9mm	72921	POA	73897	POA	
24" x 14"	609.6 x 355.6mm	72922	POA	73898	POA	
24" x 16"	609.6 x 406.4mm	72923	POA	73899	POA	
24" x 18"	609.6 x 457.2mm	72924	POA	73900	POA	
24" x 20"	609.6 x 508.0mm	72925	POA	73901	POA	

Notes

Reducer is segmentally welded.

Orders for items in shaded areas **cannot** be cancelled or returned.

Technical Data Sheet: G180

Introduction
 Couplings & Fittings
 Mechanical Tees
 Valves
 Circuit Balancing Valves
 Accessories
 Copper Systems
 Stainless Steel Systems
 Plain End Systems
 HDPE Systems
 G-MINE PVC Systems
 Gaskets & Spare Parts
 Preparation Equipment
 Miscellaneous
 Indexes

#372 Groove x Male Thread – Reducer

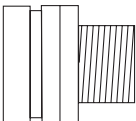
	<i>Pipe Size</i>		<i>Painted</i>		<i>Galvanized</i>	
	<i>Nominal Size</i>	<i>Outside Diameter</i>	<i>Part Number</i>	<i>List Price</i>	<i>Part Number</i>	<i>List Price</i>
	1 1/2" x 1"	48.3 x 33.4mm	76800	\$47.90	76825	\$57.57
	2" x 3/4"	60.3 x 26.7mm	76801	\$50.15	76826	\$61.41
	2" x 1"	60.3 x 33.4mm	76802	\$50.15	76827	\$61.41
	2" x 1 1/4"	60.3 x 42.4mm	76815	\$53.78	73794	\$65.68
	2" x 1 1/2"	60.3 x 48.3mm	76803	\$53.78	76828	\$65.68
	2 1/2" x 1 1/4"	73.0 x 42.4mm	76816	\$69.72	3722513GS	\$82.80
	2 1/2" x 1 1/2"	73.0 x 48.3mm	76817	\$69.72	3722515GS	\$82.80
	2 1/2" x 2"	73.0 x 60.3mm	76804	\$57.12	76829	\$71.79
	3" x 1"	88.9 x 33.4mm	76805	\$123.22	76830	\$159.63
	3" x 1 1/4"	88.9 x 42.4mm	76818	POA	3723013GS	POA
	3" x 1 1/2"	88.9 x 48.3mm	76819	\$123.22	73797	\$159.63
	3" x 2"	88.9 x 60.3mm	76806	\$123.22	76831	\$159.63
	3" x 2 1/2"	88.9 x 73.0mm	76807	\$123.22	76832	\$159.63
	4" x 1"	114.3 x 33.4mm	76808	\$129.54	76833	\$167.89
	4" x 1 1/4"	114.3 x 42.4mm	76820	POA	3724013GS	POA
	4" x 1 1/2"	114.3 x 48.3mm	76821	\$428.01	73799	\$567.44
	4" x 2"	114.3 x 60.3mm	76809	\$129.54	76834	\$167.89
	4" x 2 1/2"	114.3 x 73.0mm	76810	\$129.54	76835	\$167.89
	4" x 3"	114.3 x 88.9mm	76811	\$161.29	76836	\$209.11
	5" x 4"	141.3 x 114.3mm	73791	POA	73800	POA
6" x 1"	168.3 x 33.4mm	76812	\$160.12	76837	\$217.70	
6" x 2"	168.3 x 60.3mm	76813	\$160.12	76838	\$217.70	
6" x 3"	168.3 x 88.9mm	76814	\$160.12	76839	\$217.70	
6" x 4"	168.3 x 114.3mm	73792	POA	73801	POA	
6" x 5"	168.3 x 141.3mm	73793	POA	73802	POA	

Notes

Reducer is segmentally welded.

 Orders for items in shaded areas **cannot** be cancelled or returned.

Technical Data Sheet: G180

#391 Groove x Male Thread – Adapter Nipple

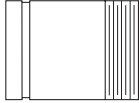
	Pipe Size			Painted		Galvanized	
	Nominal Size	Outside Diameter	Length	Part Number	List Price	Part Number	List Price
	1 1/4" x 4"	42.4mm	101.6mm	75121	\$19.14	74292	POA
	1 1/2" x 4"	48.3mm	101.6mm	75122	\$26.79	74293	POA
	2" x 4"	60.3mm	101.6mm	75123	\$26.79	74294	POA
	2" x 6"	60.3mm	152.4mm	—	POA	—	POA
	2 1/2" x 4"	73.0mm	101.6mm	75124	\$42.09	74295	POA
	3" x 4"	88.9mm	101.6mm	75125	\$53.78	74296	POA
	3" x 6"	88.9mm	152.4mm	74335	POA	—	POA
	4" x 6"	114.3mm	152.4mm	75126	\$94.04	74297	POA
	5" x 6"	141.3mm	152.4mm	75129	POA	74298	POA
	6" x 6"	168.3mm	152.4mm	75130	POA	74299	POA
	8" x 6"	219.1mm	152.4mm	75131	POA	74336	POA
	10" x 8"	273.0mm	203.2mm	75132	POA	74337	POA
	12" x 8"	323.9mm	203.2mm	75133	POA	74338	POA

Notes

Adapter Nipple is segmentally welded.

Orders for items in shaded areas **cannot** be cancelled or returned.

Technical Data Sheet: G180

#392 Groove x Groove – Adapter Nipple

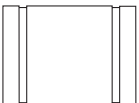
	Pipe Size			Painted		Galvanized	
	Nominal Size	Outside Diameter	Length	Part Number	List Price	Part Number	List Price
	1 1/4" x 4"	42.4mm	101.6mm	75098	POA	74339	POA
	1 1/2" x 4"	48.3mm	101.6mm	75099	\$26.79	74405	POA
	2" x 4"	60.3mm	101.6mm	75100	\$26.79	74406	POA
	2 1/2" x 4"	73.0mm	101.6mm	75101	\$42.09	74407	POA
	3" x 4"	88.9mm	101.6mm	75102	\$53.78	74408	POA
	4" x 6"	114.3mm	152.4mm	75103	\$94.04	74309	POA
	5" x 6"	141.3mm	152.4mm	75104	\$151.21	74310	POA
	6" x 6"	168.3mm	152.4mm	75105	\$200.48	74311	POA
	8" x 6"	219.1mm	152.4mm	75106	\$272.36	74312	POA
	10" x 8"	273.0mm	203.2mm	75107	\$430.31	74311	POA
	12" x 8"	323.9mm	203.2mm	75108	\$514.33	74314	POA

Notes

Adapter Nipple is segmentally welded.

Orders for items in shaded areas **cannot** be cancelled or returned.

Technical Data Sheet: G180

Introduction
 Couplings & Fittings
 Mechanical Tees
 Valves
 Circuit Balancing Valves
 Accessories
 Copper Systems
 Stainless Steel Systems
 Plain End Systems
 HDPE Systems
 G-MINE PVC Systems
 Gaskets & Spare Parts
 Preparation Equipment
 Miscellaneous
 Indexes

#393 Groove x Plain – Adapter Nipple

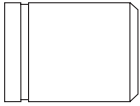
	Pipe Size			Painted		Galvanized	
	Nominal Size	Outside Diameter	Length	Part Number	List Price	Part Number	List Price
	1 1/4" x 4"	42.4mm	101.6mm	75148	\$19.14	74316	POA
	1 1/2" x 4"	48.3mm	101.6mm	74315	\$26.79	74317	POA
	2" x 4"	60.3mm	101.6mm	75150	\$26.79	74318	POA
	2 1/2" x 4"	73.0mm	101.6mm	75151	\$42.09	74319	POA
	3" x 4"	88.9mm	101.6mm	75152	\$53.78	74330	POA
	4" x 6"	114.3mm	152.4mm	75153	\$94.04	74331	POA
	5" x 6"	141.3mm	152.4mm	75158	\$151.21	74322	POA
	6" x 6"	168.3mm	152.4mm	75154	\$200.48	74323	POA
	8" x 6"	219.1mm	152.4mm	75155	\$272.34	74324	POA
	10" x 8"	273.0mm	203.2mm	75156	\$430.31	74325	POA
	12" x 8"	323.9mm	203.2mm	75157	\$514.33	74326	POA

Notes

Adapter Nipple is segmentally welded.

 Orders for items in shaded areas *cannot* be cancelled or returned.

Technical Data Sheet: G180
#395 Hose Adapter Nipple, Groove x Hose

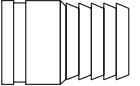
	Pipe Size			Painted		Galvanized	
	Nominal Size	Outside Diameter	Length	Part Number	List Price	Part Number	List Price
	1" x 3 1/4"	33.4mm	82.6mm	72680	\$37.49	72692	POA
	1 1/4" x 3 5/8"	42.4mm	92.1mm	72681	\$37.49	72693	POA
	1 1/2" x 4"	48.3mm	101.6mm	72682	\$58.09	72694	POA
	2" x 4 5/8"	60.3mm	117.5mm	72683	\$66.53	72695	\$81.41
	2 1/2" x 5 1/2"	73.0mm	139.7mm	72684	\$74.97	72696	\$92.39
	3" x 6"	88.9mm	152.4mm	72685	\$94.08	72697	\$111.81
	4" x 7 1/4"	114.3mm	184.2mm	72686	\$115.74	72698	\$233.37
	5" x 9 3/4"	141.3mm	247.7mm	72687	\$272.49	72699	\$354.23
	6" x 11"	168.3mm	279.4mm	72688	\$319.56	72620	\$386.29
	8" x 12 1/2"	219.1mm	317.5mm	72689	\$711.63	72621	POA
	10" x 14"	273.0mm	355.6mm	72690	\$520.89	72622	POA
	12" x 16"	323.9mm	406.4mm	72691	POA	72623	POA

Notes

Adapter Nipple is segmentally welded.

 Orders for items in shaded areas *cannot* be cancelled or returned.

Technical Data Sheet: G180

#380 Female Thread Adapter, Groove x Female Pipe Thread

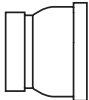
	Pipe Size		Painted		Galvanized	
	Nominal Size	Outside Diameter	Part Number	List Price	Part Number	List Price
	1"	33.4mm	72601	\$87.78	72607	\$107.35
1 1/4"	42.4mm	72602	\$87.78	72608	\$98.57	
1 1/2"	48.3mm	72603	\$98.52	72609	\$122.27	
2"	60.3mm	72604	\$98.52	72610	\$127.71	
2 1/2"	73.0mm	72613	\$150.53	72614	\$168.91	
3"	88.9mm	72605	\$159.13	72611	\$206.86	
4"	114.3mm	72606	\$159.13	72612	\$206.86	
Notes						
Adapter is segmentally welded.						
Orders for items in shaded areas <i>cannot</i> be cancelled or returned.						
Technical Data Sheet: G180						

#314 Grooved Lateral

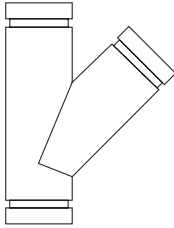
	Pipe Size		Painted		Galvanized	
	Nominal Size	Outside Diameter	Part Number	List Price	Part Number	List Price
	2"	60.3mm	75700	\$278.93	74700	\$351.17
2 1/2"	73.0mm	75701	\$284.16	74701	\$352.61	
3"	88.9mm	75702	\$308.00	74702	\$399.17	
4"	114.3mm	75703	\$484.17	74703	\$611.42	
5"	141.3mm	73902	\$694.57	73903	\$899.68	
6"	168.3mm	75704	\$1,031.36	74704	\$1,380.90	
8"	219.1mm	75705	\$1,320.10	74705	\$1,726.85	
10"	273.0mm	75706	\$1,863.34	73904	POA	
12"	323.9mm	75707	\$2,048.26	73905	POA	
14"	355.6mm	75708	POA	73906	POA	
16"	406.4mm	75709	POA	73907	POA	
18"	457.2mm	75710	POA	73908	POA	
20"	508.0mm	75711	POA	73909	POA	
24"	609.6mm	75712	POA	73910	POA	
Notes						
Lateral is segmentally welded.						
Orders for items in shaded areas <i>cannot</i> be cancelled or returned.						
Technical Data Sheet: G180						

Introduction
Couplings & Fittings
Mechanical Tees
Valves
Circuit Balancing Valves
Accessories
Copper Systems
Stainless Steel Systems
Plain End Systems
HDPE Systems
G-MINE PVC Systems
Gaskets & Spare Parts
Preparation Equipment
Miscellaneous
Indexes

#325 Grooved Reducing Lateral

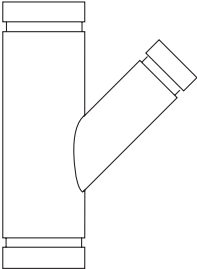
	Pipe Size		Painted	
	Nominal Size	Outside Diameter	Part Number	List Price
	3" x 3" x 2"	88.9 x 88.9 x 60.3mm	75670	\$340.00
	3" x 3" x 2 1/2"	88.9 x 88.9 x 73.0mm	75671	\$340.00
	4" x 4" x 2"	114.3 x 114.3 x 60.3mm	75672	\$668.00
	4" x 4" x 2 1/2"	114.3 x 114.3 x 73.0mm	75673	\$668.00
	4" x 4" x 3"	114.3 x 114.3 x 88.9mm	75674	\$654.83
	5" x 5" x 2"	141.3 x 141.3 x 60.3mm	75675	\$735.22
	5" x 5" x 2 1/2"	141.3 x 141.3 x 73.0mm	73911	POA
	5" x 5" x 3"	141.3 x 141.3 x 88.9mm	75676	\$975.50
	5" x 5" x 4"	141.3 x 141.3 x 114.3mm	75677	\$481.07
	6" x 6" x 2"	168.3 x 168.3 x 60.3mm	75678	POA
	6" x 6" x 2 1/2"	168.3 x 168.3 x 73.0mm	73912	POA
	6" x 6" x 3"	168.3 x 168.3 x 88.9mm	75679	\$759.46
	6" x 6" x 4"	168.3 x 168.3 x 114.3mm	75680	\$613.03
	6" x 6" x 5"	168.3 x 168.3 x 141.3mm	75681	\$1,259.50
	8" x 8" x 4"	219.1 x 219.1 x 114.3mm	75682	\$1225.39
	8" x 8" x 5"	219.1 x 219.1 x 141.3mm	75683	\$1,817.50
	8" x 8" x 6"	219.1 x 219.1 x 168.3mm	75684	\$1233.89
	10" x 10" x 4"	273.0 x 273.0 x 114.3mm	75685	\$1757.16
	10" x 10" x 5"	273.0 x 273.0 x 141.3mm	75686	POA
	10" x 10" x 6"	273.0 x 273.0 x 168.3mm	75687	\$1927.97
	10" x 10" x 8"	273.0 x 273.0 x 219.1mm	75688	\$1974.87
	12" x 12" x 4"	323.9 x 323.9 x 114.3mm	75689	POA
	12" x 12" x 6"	323.9 x 323.9 x 168.3mm	75690	\$2,677.50
	12" x 12" x 8"	323.9 x 323.9 x 219.1mm	75691	\$2,712.00
	12" x 12" x 10"	323.9 x 323.9 x 273.0mm	75692	\$2,748.00
	14" x 14" x 4"	355.6 x 355.6 x 114.3mm	73913	\$1,868.00
	14" x 14" x 6"	355.6 x 355.6 x 168.3mm	73914	\$2,005.50
	14" x 14" x 8"	355.6 x 355.6 x 219.1mm	73915	\$2,157.00
	14" x 14" x 10"	355.6 x 355.6 x 273.0mm	73916	\$2,734.00
	14" x 14" x 12"	355.6 x 355.6 x 323.9mm	73917	\$2,775.00
	16" x 16" x 6"	406.4 x 406.4 x 168.3mm	73918	\$2,907.00
	16" x 16" x 8"	406.4 x 406.4 x 219.1mm	73919	\$3,074.00
16" x 16" x 10"	406.4 x 406.4 x 273.0mm	73920	\$3,587.50	
16" x 16" x 12"	406.4 x 406.4 x 323.9mm	73921	\$3,739.00	
16" x 16" x 14"	406.4 x 406.4 x 355.6mm	73922	\$3,739.00	
18" x 18" x 6"	457.2 x 457.2 x 168.3mm	73923	\$3,739.00	
18" x 18" x 8"	457.2 x 457.2 x 219.1mm	73924	\$3,739.00	
18" x 18" x 10"	457.2 x 457.2 x 273.0mm	73925	POA	
18" x 18" x 12"	457.2 x 457.2 x 323.9mm	73926	\$4,155.50	
18" x 18" x 14"	457.2 x 457.2 x 355.6mm	73927	\$4,974.50	
18" x 18" x 16"	457.2 x 457.2 x 406.4mm	73928	\$5,595.50	
20" x 20" x 12"	508.0 x 508.0 x 323.9mm	73929	\$5,347.50	
20" x 20" x 14"	508.0 x 508.0 x 355.6mm	73930	\$5,512.50	
20" x 20" x 16"	508.0 x 508.0 x 406.4mm	73931	\$6,502.50	
24" x 24" x 16"	609.6 x 609.6 x 406.4mm	73932	\$12,343.00	
24" x 24" x 20"	609.6 x 609.6 x 508.0mm	73933	\$13,427.00	

Notes

Lateral is segmentally welded.

 Orders for items in shaded areas **cannot** be cancelled or returned.

Technical Data Sheet: G180

#324 Grooved Wye						
	Pipe Size		Painted		Galvanized	
	Nominal Size	Outside Diameter	Part Number	List Price	Part Number	List Price
	1 1/4"	42.4mm	75901	\$377.00	74224	POA
	1 1/2"	48.3mm	75902	\$377.00	74225	\$448.50
	2"	60.3mm	75903	\$253.64	74226	\$309.70
	2 1/2"	73.0mm	75904	\$377.00	74227	\$264.28
	3"	88.9mm	75905	\$303.23	74228	\$369.55
	4"	114.3mm	75906	\$397.10	74229	\$491.28
	5"	141.3mm	75907	\$569.29	74230	\$651.34
	6"	168.3mm	75908	\$704.43	74231	\$880.83
	8"	219.1mm	75909	\$1,014.59	74232	\$1,238.35
	10"	273.0mm	75910	\$1,751.20	74233	\$3,174.50
	12"	323.9mm	75911	\$1,890.73	74234	\$2,327.41
	14"	355.6mm	75912	\$2,585.50	74235	\$3,227.00
	16"	406.4mm	75913	\$3,593.50	74236	\$4,291.00
	18"	457.2mm	75914	\$4,190.00	74237	\$5,115.50
	20"	508.0mm	75915	\$5,606.50	74238	\$6,938.50
	24"	609.6mm	75916	\$9,997.50	74239	\$10,535.00
Notes						
Wye is segmentally welded.						
Orders for items in shaded areas <i>cannot</i> be cancelled or returned.						
Technical Data Sheet: G180						

#331 Grooved Reducing Tee Wye							
	Pipe Size		Painted		Galvanized		
	Nominal Size	Outside Diameter	Part Number	List Price	Part Number	List Price	
	4" x 3" x 3"	114.3 x 88.9 x 88.9mm	72037	\$1,011.50	74213	\$1,202.50	
	4" x 3" x 4"	114.3 x 88.9 x 114.3mm	75734	\$1,437.50	74214	\$1,723.00	
	5" x 3" x 3"	141.3 x 88.9 x 88.9mm	74207	\$1,367.00	74215	\$1,602.50	
	5" x 3" x 5"	141.3 x 88.9 x 141.3mm	75736	POA	74216	POA	
	5" x 4" x 3"	141.3 x 114.3 x 88.9mm	74208	POA	74217	POA	
	5" x 4" x 4"	141.3 x 114.3 x 114.3mm	75737	POA	74218	POA	
	6" x 4" x 6"	168.3 x 114.3 x 168.3mm	74209	\$5,128.00	74219	POA	
	6" x 5" x 3"	168.3 x 141.3 x 88.9mm	74210	POA	74220	POA	
	6" x 5" x 4"	168.3 x 141.3 x 114.3mm	74211	POA	74221	POA	
	8" x 6" x 4"	219.1 x 168.3 x 114.3mm	74212	POA	74222	\$3,214.00	
	8" x 6" x 8"	219.1 x 168.3 x 219.1mm	75746	\$6,008.00	74223	\$6,615.00	
	Notes						
	Wye is segmentally welded.						
	Orders for items in shaded areas <i>cannot</i> be cancelled or returned.						
Technical Data Sheet: G180							

Introduction
Couplings & Fittings
Mechanical Tees
Valves
Circuit Balancing Valves
Accessories
Copper Systems
Stainless Steel Systems
Plain End Systems
HDPE Systems
G-MINE PVC Systems
Gaskets & Spare Parts
Preparation Equipment
Miscellaneous
Indexes

#330 Grooved Tee Wye

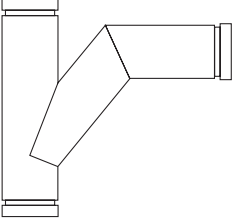
	Pipe Size		Painted		Galvanized	
	Nominal Size	Outside Diameter	Part Number	List Price	Part Number	List Price
	2" x 2" x 2"	60.3 x 60.3 x 60.3mm	75730	\$683.50	73977	\$814.50
	2 1/2" x 2 1/2" x 2 1/2"	73.0 x 73.0 x 73.0mm	75731	\$683.50	73978	\$814.50
	3" x 3" x 3"	88.9 x 88.9 x 88.9mm	75732	\$783.50	73979	\$946.00
	4" x 4" x 3"	114.3 x 114.3 x 88.9mm	73957	\$944.50	73980	\$888.05
	4" x 4" x 4"	114.3 x 114.3 x 114.3mm	75735	\$851.32	73981	POA
	5" x 5" x 3"	141.3 x 141.3 x 88.9mm	73958	\$1,367.00	73982	\$1,602.50
	5" x 5" x 4"	141.3 x 141.3 x 114.3mm	73959	\$1,575.50	73983	\$1,759.50
	5" x 5" x 5"	141.3 x 141.3 x 141.3mm	75738	\$2,315.50	73984	\$2,828.50
	6" x 6" x 3"	168.3 x 168.3 x 88.9mm	73960	\$1,119.50	73985	\$1,445.50
	6" x 6" x 4"	168.3 x 168.3 x 114.3mm	73961	\$1,364.50	73986	\$1,706.00
	6" x 6" x 5"	168.3 x 168.3 x 141.3mm	73962	POA	73987	POA
	6" x 6" x 6"	168.3 x 168.3 x 168.3mm	75742	\$1,874.04	73988	\$2,567.50
	8" x 8" x 3"	219.1 x 219.1 x 88.9mm	73963	\$1,333.50	73989	\$1,937.00
	8" x 8" x 4"	219.1 x 219.1 x 114.3mm	73964	\$1,588.50	73990	\$2,189.50
	8" x 8" x 5"	219.1 x 219.1 x 141.3mm	73965	\$2,103.00	73991	\$2,766.50
	8" x 8" x 6"	219.1 x 219.1 x 168.3mm	73966	\$2,293.50	73992	\$2,999.50
	8" x 8" x 8"	219.1 x 219.1 x 219.1mm	75759	\$2,407.57	73993	\$3,504.38
	10" x 10" x 3"	273.0 x 273.0 x 88.9mm	73967	\$1,837.00	73994	\$2,547.00
	10" x 10" x 4"	273.0 x 273.0 x 114.3mm	73968	\$2,014.50	73995	\$2,766.50
	10" x 10" x 5"	273.0 x 273.0 x 141.3mm	73969	POA	73996	\$3,375.00
	10" x 10" x 6"	273.0 x 273.0 x 168.3mm	73970	\$2,672.50	73997	\$3,545.50
	10" x 10" x 8"	273.0 x 273.0 x 219.1mm	73971	\$3,467.00	73998	\$4,460.50
	10" x 10" x 10"	273.0 x 273.0 x 273.0mm	75752	\$4,439.46	73999	\$5,806.00
	12" x 12" x 3"	323.9 x 323.9 x 88.9mm	73972	POA	72031	POA
	12" x 12" x 4"	323.9 x 323.9 x 114.3mm	73973	POA	72032	POA
	12" x 12" x 6"	323.9 x 323.9 x 168.3mm	73974	POA	72033	POA
	12" x 12" x 8"	323.9 x 323.9 x 219.1mm	73975	POA	72034	POA
	12" x 12" x 10"	323.9 x 323.9 x 273.0mm	73976	POA	72035	POA
12" x 12" x 12"	323.9 x 323.9 x 323.9mm	75758	\$6,243.50	72036	\$7,928.00	

Notes

Wye is segmentally welded.

 Orders for items in shaded areas *cannot* be cancelled or returned.

Technical Data Sheet: G180

#327 – Grooved Cross

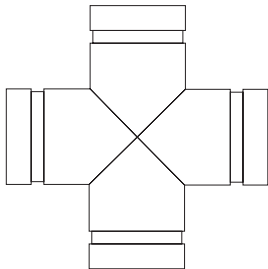
	Pipe Size		Painted		Galvanized	
	Nominal Size	Outside Diameter	Part Number	List Price	Part Number	List Price
	1 1/4"	42.4mm	73728	\$247.75	73736	\$270.03
1 1/2"	48.3mm	73729	\$247.75	73738	\$270.03	
2"	60.3mm	75840	\$127.28	75849	\$156.58	
2 1/2"	73.0mm	75841	\$127.28	75850	\$156.58	
3"	88.9mm	75842	\$228.94	75851	\$289.52	
4"	114.3mm	75843	\$388.18	75852	\$483.96	
5"	141.3mm	73730	\$778.28	73739	\$893.12	
6"	168.3mm	75845	\$1,020.48	75853	\$1,253.43	
8"	219.1mm	75846	\$1,343.95	76757	\$1,683.74	
10"	273.0mm	75847	\$2,249.31	76758	\$2,857.14	
12"	323.9mm	75848	\$3,245.91	76759	\$3,570.52	
14"	355.6mm	73731	\$3,403.13	73742	\$4,083.79	
16"	406.4mm	73732	\$4,874.28	73743	\$5,849.16	
18"	457.2mm	73733	\$5,958.59	73744	\$7,150.30	
20"	508.0mm	73734	\$7,102.17	73745	\$8,522.61	
24"	609.6mm	73735	\$10,442.78	73746	\$12,531.32	

Notes

Cross is segmentally welded.

Orders for items in shaded areas **cannot** be cancelled or returned.

Technical Data Sheet: G180

Introduction
 Couplings & Fittings
 Mechanical Tees
 Valves
 Circuit Balancing Valves
 Accessories
 Copper Systems
 Stainless Steel Systems
 Plain End Systems
 HDPE Systems
 G-MINE PVC Systems
 Gaskets & Spare Parts
 Preparation Equipment
 Miscellaneous
 Indexes

#260 and #360 – Grooved Cap

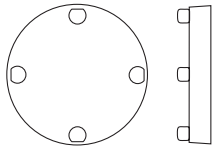
	Pipe Size		Painted		Galvanized	
	Nominal Size	Outside Diameter	Part Number	List Price	Part Number	List Price
	1" *	33.4mm	260M000341	\$14.48	260M000342	\$17.96
	1 1/4" *	42.4mm	260M000421	\$14.48	260M000422	\$17.96
	1 1/2" *	48.3mm	260M000481	\$14.48	260M000482	\$17.96
	2" *	60.3mm	260M000601	\$14.48	260M000602	\$17.96
	2 1/2" *	73.0mm	260M000731	\$22.99	260M000732	\$27.21
	76.1mm *	76.1mm	260M000761	\$22.99	260M000762	\$28.41
	3" *	88.9mm	260M000891	\$22.99	260M000892	\$28.41
	4" *	114.3mm	260M001141	\$26.68	260M001142	\$33.19
	139.7mm *	139.7mm	260M001391	\$56.22	260M001392	\$69.74
	5" *	141.3mm	260M001411	\$56.22	260M001412	\$69.74
	165.1mm *	165.1mm	260M001651	\$63.70	260M001652	\$79.04
	6" *	168.3mm	260M001681	\$63.70	260M001682	\$79.04
	8" *	219.1mm	260M002191	\$125.75	260M002192	\$156.19
	10" *	273.0mm	260M002731	\$271.79	260M002732	\$335.58
	12" *	323.9mm	260M003241	\$456.51	260M003242	\$563.67
	14"	355.6mm	73807	\$2,000.86	75488	\$2,441.70
	16"	406.4mm	73803	\$2,016.24	73808	\$2,460.59
	18"	457.2mm	73804	\$2,537.96	73809	\$3,097.27
20"	508.0mm	73805	\$2,857.10	73810	\$3,486.84	
24"	609.6mm	73806	\$3,945.89	73811	\$4,815.49	

Notes

Cap is segmentally welded except where a * indicates it is available as a cast fitting.

 Orders for items in shaded areas **cannot** be cancelled or returned.

Technical Data Sheet: G180
#260 Cast – Grooved Cap with 1/2" Tap

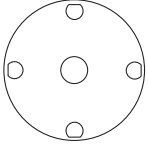
	Pipe Size		Painted	
	Nominal Size	Outside Diameter	Part Number	List Price
	1 1/4"	42.4mm	26013TS	\$15.73
	1 1/2"	48.3mm	26015TS	\$15.73
	2"	60.3mm	26020TS	\$15.73
	2 1/2"	73.0mm	26025TS	\$24.59
	3"	88.9mm	26030TS	\$24.59
	4"	114.3mm	26040TS	\$26.75
	5"	141.3mm	26050TS	\$62.89
	6"	168.3mm	26060TS	\$62.89
	8"	219.1mm	26080TS	\$124.07
	10"	273.0mm	26010TS	\$224.98
	12"	323.9mm	26012TS	\$368.79

Note

 Orders for items in shaded areas **cannot** be cancelled or returned.

Technical Data Sheet: G180

#363 Cast – Grooved Cap with 3/4" Tap

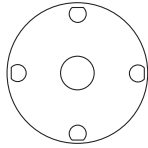
	Pipe Size		Painted		Galvanized	
	Nominal Size	Outside Diameter	Part Number	List Price	Part Number	List Price
	2"	60.3mm	363M000601	\$70.08	363M000602	\$78.75
	76.1mm	76.1mm	363M000761	\$70.08	363M000762	\$78.75
	3"	88.9mm	363M000891	\$70.08	363M000892	\$78.75
	4"	114.3mm	363M001141	\$86.76	363M001142	\$93.33
	139.7mm	139.7mm	363M001391	\$110.10	363M001392	\$121.29
	5"	141.3mm	363M001411	\$86.76	363M001412	\$93.33
	165.1mm	165.1mm	363M001651	\$133.44	363M001652	\$153.94
	6"	168.3mm	363M001681	\$133.44	363M001682	\$153.94
	8"	219.1mm	363M002191	\$240.22	363M002192	\$293.87
	10"	273.0mm	26010T75S	\$334.56	363M002732	POA
	12"	323.9mm	26012T75S	POA	363M003242	POA

Note

Orders for items in shaded areas *cannot* be cancelled or returned.

Technical Data Sheet: G180

#364 Cast – Grooved Cap with 1" Tap

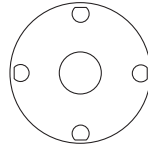
	Pipe Size		Painted		Galvanized	
	Nominal Size	Outside Diameter	Part Number	List Price	Part Number	List Price
	2"	60.3mm	364M000601	\$70.08	364M000602	\$78.75
	76.1mm	76.1mm	364M000761	\$70.08	364M000762	\$78.75
	3"	88.9mm	364M000891	\$70.08	364M000892	\$78.75
	4"	114.3mm	364M001141	\$86.76	364M001142	\$93.33
	139.7mm	139.7mm	364M001391	\$110.10	364M001392	\$121.29
	5"	141.3mm	364M001411	\$110.10	364M001412	\$121.29
	165.1mm	165.1mm	364M001651	\$133.44	364M001652	\$153.94
	6"	168.3mm	364M001681	\$133.44	364M001682	\$153.94
	8"	219.1mm	364M002191	\$240.22	364M002192	\$293.87
	10"	273.0mm	26010T1S	POA	-	POA
	12"	323.9mm	26012T1S	POA	-	POA

Note

Orders for items in shaded areas *cannot* be cancelled or returned.

Technical Data Sheet: G180

Introduction

Couplings & Fittings

Mechanical Tees

Valves

Circuit Balancing Valves

Accessories

Copper Systems

Stainless Steel Systems

Plain End Systems

HDPE Systems

G-MINE PVC Systems

Gaskets & Spare Parts

Preparation Equipment

Miscellaneous

Indexes

#361 Cast – Grooved Cap with 1-1/2" Tap

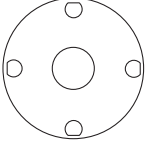
	Pipe Size		Painted		Galvanized	
	Nominal Size	Outside Diameter	Part Number	List Price	Part Number	List Price
	2"	60.3mm	361M000601	\$70.08	361M000602	\$78.75
	76.1mm	76.1mm	361M000761	\$70.08	361M000762	\$78.75
	3"	88.9mm	361M000891	\$70.08	361M000892	\$78.75
	4"	114.3mm	361M001141	\$86.76	361M001142	\$93.33
	139.7mm	139.7mm	361M001391	\$110.10	361M001392	\$93.33
	5"	141.3mm	361M001411	\$110.10	361M001412	\$93.33
	165.1mm	165.1mm	361M001651	\$133.44	361M001652	\$153.94
	6"	168.3mm	361M001681	\$133.44	361M001682	\$153.94
	8"	219.1mm	361M002191	\$240.22	361M002192	\$293.87
	10"	273.0mm	361M002731	\$391.02	361M002732	\$436.05

Note

 Orders for items in shaded areas *cannot* be cancelled or returned.

Technical Data Sheet: G180
#362 Cast – Grooved Cap with 2" Tap

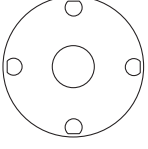
	Pipe Size		Painted		Galvanized	
	Nominal Size	Outside Diameter	Part Number	List Price	Part Number	List Price
	76.1mm	76.1mm	362M000761	\$74.86	362M000762	\$83.76
	3"	88.9mm	362M000891	\$74.86	362M000892	\$83.76
	4"	114.3mm	362M001141	\$86.76	362M001142	\$125.97
	139.7mm	139.7mm	362M001391	\$116.75	362M001392	\$129.29
	5"	141.3mm	362M001411	\$116.75	362M001412	\$129.29
	165.1mm	165.1mm	362M001651	\$133.44	362M001652	\$153.94
	6"	168.3mm	362M001681	\$133.44	362M001682	\$153.94
	8"	219.1mm	362M002191	\$240.22	362M002192	\$293.87
	10"	273.0mm	361M002731	\$391.02	362M002732	\$436.05

Note

 Orders for items in shaded areas *cannot* be cancelled or returned.

Technical Data Sheet: G180

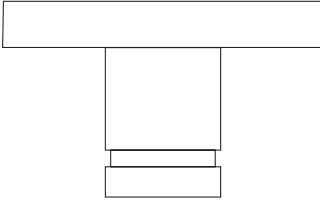
#341 Groove x Flange – Adapter 150#						
	Pipe Size		Painted		Galvanized	
	Nominal Size	Outside Diameter	Part Number	List Price	Part Number	List Price
	1 1/4"	42.4mm	74240	POA	74245	POA
	1 1/2"	48.3mm	J74241	\$277.50	74246	\$121.69
	2"	60.3mm	73230	\$118.50	34120GS	\$173.25
	2 1/2"	73.0mm	73231	\$373.30	J73251	\$541.29
	3"	88.9mm	73232	\$373.31	J73252	\$541.29
	4"	114.3mm	73233	\$406.69	J73253	\$499.60
	5"	141.3mm	73234	\$554.34	J73254	\$660.67
	6"	168.3mm	73235	\$564.24	J73255	\$622.37
	8"	219.1mm	73236	\$592.07	73256	\$905.18
	10"	273.0mm	73237	\$926.57	74265	\$1,033.75
	12"	323.9mm	73238	\$1,222.54	74254	\$1,771.82
	14"	355.6mm	73239	\$1,625.17	34114GS	\$2,357.31
	16"	406.4mm	73240	\$2,186.45	74256	\$3,659.04
	18"	457.2mm	73241	\$2,759.72	74257	\$3,790.23
	20"	508.0mm	73242	\$3,659.04	74258	\$3,980.23
	24"	609.6mm	73243	\$4,730.68	74259	\$4,893.50
Notes						
Adapter is segmentally welded.						
Orders for items in shaded areas cannot be cancelled or returned.						
Technical Data Sheet: G180						

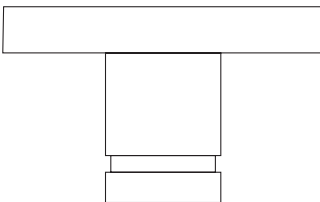
#342 Groove x Flange – Adapter 300#						
	Pipe Size		Painted		Galvanized	
	Nominal Size	Outside Diameter	Part Number	List Price	Part Number	List Price
	1"	33.4mm	–	POA	–	POA
	1 1/4"	42.4mm	74260	\$240.51	74276	\$374.63
	1 1/2"	48.3mm	74261	\$259.45	74277	\$395.34
	2"	60.3mm	74262	\$265.78	74278	\$402.63
	2 1/2"	73.0mm	74263	\$340.50	74279	\$400.50
	3"	88.9mm	74264	\$281.07	74280	\$436.94
	4"	114.3mm	73260	\$473.26	73263	\$548.29
	5"	141.3mm	73261	\$567.95	73264	POA
	6"	168.3mm	73262	\$532.85	74283	\$585.77
	8"	219.1mm	74268	\$934.22	34280GS	\$1,083.88
	10"	273.0mm	74269	\$1,455.78	74285	POA
	12"	323.9mm	74270	\$2,601.50	74286	\$3,342.50
	14"	355.6mm	74271	POA	74287	POA
	16"	406.4mm	74272	POA	74288	POA
	18"	457.2mm	74273	POA	74289	POA
	20"	508.0mm	74274	POA	74290	POA
	24"	609.6mm	74275	POA	74291	POA
Notes						
Adapter is segmentally welded.						
Orders for items in shaded areas cannot be cancelled or returned.						
Technical Data Sheet: G180						

Introduction
Couplings & Fittings
Mechanical Tees
Valves
Circuit Balancing Valves
Accessories
Copper Systems
Stainless Steel Systems
Plain End Systems
HDPE Systems
G-MINE PVC Systems
Gaskets & Spare Parts
Preparation Equipment
Miscellaneous
Indexes

#397 Groove x Groove – Swaged Nipple

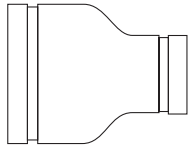
	Pipe Size		Painted	
	Nominal Size	Outside Diameter	Part Number	List Price
	2" x 1"	60.3 x 33.4mm	76840	\$171.41
	2" x 1 1/4"	60.3 x 42.4mm	76841	\$148.49
	2" x 1 1/2"	60.3 x 48.3mm	76842	\$148.39
	2 1/2" x 1"	73.0 x 33.4mm	76843	\$239.56
	2 1/2" x 1 1/4"	73.0 x 42.4mm	76844	\$259.99
	2 1/2" x 1 1/2"	73.0 x 48.3mm	76845	\$259.99
	2 1/2" x 2"	73.0 x 60.3mm	76846	\$259.99
	3" x 1"	88.9 x 33.4mm	76847	\$168.20
	3" x 1 1/4"	88.9 x 42.4mm	76848	\$252.32
	3" x 1 1/2"	88.9 x 48.3mm	76849	\$160.12
	3" x 2"	88.9 x 60.3mm	76850	\$130.84
	3" x 2 1/2"	88.9 x 73.0mm	76851	\$130.84
	4" x 1"	114.3 x 33.4mm	76853	\$439.50
	4" x 1 1/4"	114.3 x 42.4mm	76854	\$439.50
	4" x 1 1/2"	114.3 x 48.3mm	76855	\$316.87
	4" x 2"	114.3 x 60.3mm	76856	\$384.86
	4" x 2 1/2"	114.3 x 73.0mm	76857	\$384.86
	4" x 3"	114.3 x 88.9mm	76858	\$437.59
	5" x 2"	141.3 x 60.3mm	76860	\$548.57
	5" x 3"	141.3 x 88.9mm	76861	\$548.57
	5" x 4"	141.3 x 114.3mm	76862	\$538.78
	6" x 1"	168.3 x 33.4mm	76863	\$1,017.56
	6" x 1 1/4"	168.3 x 42.4mm	76864	\$2,318.50
	6" x 1 1/2"	168.3 x 48.3mm	76865	\$2,318.50
	6" x 2"	168.3 x 60.3mm	76866	\$1,115.50
	6" x 2 1/2"	168.3 x 73.0mm	76867	\$1,115.50
	6" x 3"	168.3 x 88.9mm	76868	\$1,115.50
	6" x 4"	168.3 x 114.3mm	76870	\$845.00
6" x 5"	168.3 x 141.3mm	76871	\$671.78	
8" x 6"	219.1 x 168.3mm	72038	\$1,455.23	

Notes

Nipple is segmentally welded.

 Orders for items in shaded areas **cannot** be cancelled or returned.

Technical Data Sheet: G180

#398 Groove x Male Thread – Swaged Nipple

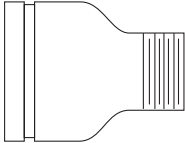
	Pipe Size		Painted	
	Nominal Size	Outside Diameter	Part Number	List Price
	2" x 1"	60.3 x 33.4mm	77001	\$171.41
	2" x 1 1/4"	60.3 x 42.4mm	77002	\$148.39
	2" x 1 1/2"	60.3 x 48.3mm	77003	\$148.39
	2 1/2" x 1"	73.0 x 33.4mm	77004	\$239.56
	2 1/2" x 1 1/4"	73.0 x 42.4mm	77005	\$259.99
	2 1/2" x 1 1/2"	73.0 x 48.3mm	77006	\$259.99
	2 1/2" x 2"	73.0 x 60.3mm	77007	\$259.99
	3" x 1"	88.9 x 33.4mm	77008	\$168.20
	3" x 1 1/4"	88.9 x 42.4mm	77009	\$252.32
	3" x 1 1/2"	88.9 x 48.3mm	77010	\$160.12
	3" x 2"	88.9 x 60.3mm	77011	\$130.84
	3" x 2 1/2"	88.9 x 73.0mm	77012	\$130.84
	4" x 1"	114.3 x 33.4mm	77014	\$439.50
	4" x 1 1/4"	114.3 x 42.4mm	77015	\$439.50
	4" x 1 1/2"	114.3 x 48.3mm	77016	\$316.87
	4" x 2"	114.3 x 60.3mm	77017	\$384.86
	4" x 2 1/2"	114.3 x 73.0mm	77018	\$384.86
	4" x 3"	114.3 x 88.9mm	77019	\$437.59
	5" x 2"	141.3 x 60.3mm	77021	\$548.57
	5" x 3"	141.3 x 88.9mm	77022	\$548.57
	5" x 4"	141.3 x 114.3mm	77023	\$538.78
	6" x 1"	168.3 x 33.4mm	77024	\$1,017.56
	6" x 1 1/4"	168.3 x 42.4mm	77025	\$1,017.56
	6" x 1 1/2"	168.3 x 48.3mm	77026	\$1,017.56
	6" x 2"	168.3 x 60.3mm	77027	\$1,115.50
	6" x 2 1/2"	168.3 x 73.0mm	77028	\$1,115.50
	6" x 3"	168.3 x 88.9mm	77029	\$1,115.50
	6" x 4"	168.3 x 114.3mm	77031	\$555.21
6" x 5"	168.3 x 141.3mm	77032	\$671.78	
8" x 6"	219.1 x 168.3mm	72039	\$1,345.50	

Notes

Nipple is segmentally welded.

Orders for items in shaded areas **cannot** be cancelled or returned.

Technical Data Sheet: G180

Introduction
 Couplings & Fittings
 Mechanical Tees
 Valves
 Circuit Balancing Valves
 Accessories
 Copper Systems
 Stainless Steel Systems
 Plain End Systems
 HDPE Systems
 G-MINE PVC Systems
 Gaskets & Spare Parts
 Preparation Equipment
 Miscellaneous
 Indexes

#399 Groove x Plain – Swaged Nipple

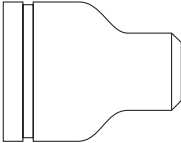
	Pipe Size		Painted	
	Nominal Size	Outside Diameter	Part Number	List Price
	2" x 1"	60.3 x 33.4mm	76051	\$171.41
	2" x 1 ¹ / ₄ "	60.3 x 42.4mm	76052	\$148.39
	2" x 1 ¹ / ₂ "	60.3 x 48.3mm	76053	\$148.39
	2 ¹ / ₂ " x 1"	73.0 x 33.4mm	76054	\$239.56
	2 ¹ / ₂ " x 1 ¹ / ₄ "	73.0 x 42.4mm	76055	\$259.99
	2 ¹ / ₂ " x 1 ¹ / ₂ "	73.0 x 48.3mm	76056	\$259.99
	2 ¹ / ₂ " x 2"	73.0 x 60.3mm	76057	\$259.99
	3" x 1"	88.9 x 33.4mm	76058	\$168.20
	3" x 1 ¹ / ₄ "	88.9 x 42.4mm	76059	\$252.32
	3" x 1 ¹ / ₂ "	88.9 x 48.3mm	76060	\$160.12
	3" x 2"	88.9 x 60.3mm	76061	\$130.84
	3" x 2 ¹ / ₂ "	88.9 x 73.0mm	76062	\$130.84
	4" x 1"	114.3 x 33.4mm	76064	\$439.50
	4" x 1 ¹ / ₄ "	114.3 x 42.4mm	76065	\$439.50
	4" x 1 ¹ / ₂ "	114.3 x 48.3mm	76066	\$316.87
	4" x 2"	114.3 x 60.3mm	76067	\$384.86
	4" x 2 ¹ / ₂ "	114.3 x 73.0mm	76068	\$384.86
	4" x 3"	114.3 x 88.9mm	76069	\$437.59
	5" x 2"	141.3 x 60.3mm	76071	\$548.57
	5" x 3"	141.3 x 88.9mm	76072	\$548.57
	5" x 4"	141.3 x 114.3mm	76073	\$538.78
	6" x 1"	168.3 x 33.4mm	76074	\$1,017.56
	6" x 1 ¹ / ₄ "	168.3 x 42.4mm	76075	\$1,017.56
	6" x 1 ¹ / ₂ "	168.3 x 48.3mm	76076	\$1,017.56
	6" x 2"	168.3 x 60.3mm	76077	\$1,115.50
	6" x 2 ¹ / ₂ "	168.3 x 73.0mm	76078	\$1,115.50
	6" x 3"	168.3 x 88.9mm	76079	\$1,115.50
	6" x 4"	168.3 x 114.3mm	76081	\$555.21
6" x 5"	168.3 x 141.3mm	76082	\$671.78	
8" x 6"	219.1 x 168.3mm	72040	\$1,345.50	

Notes

Nipple is segmentally welded.

 Orders for items in shaded areas **cannot** be cancelled or returned.

Technical Data Sheet: G180

**#730 Mechanical Tee – Threaded
 with Grade “E” Gasket**

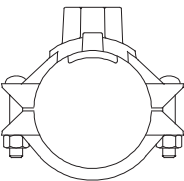
	Pipe Size		Painted		Galvanized	
	Nominal Size	Outside Diameter	Grade “E” EPDM	List Price	Grade “E” EPDM	List Price
	2" x 1/2"	60.3 x 21.3mm	730AT20051	\$30.58	730AT20052	\$39.57
	2" x 3/4"	60.3 x 26.7mm	730AT20071	\$30.58	730AT20072	\$39.57
	2" x 1"	60.3 x 33.4mm	730AT20101	\$30.58	730AT20102	\$39.57
	2" x 1 1/4"	60.3 x 42.4mm	730AT20121	\$35.36	730AT20122	\$45.82
	2" x 1 1/2"	60.3 x 48.3mm	730AT20151	\$35.36	730AT20152	\$45.82
	2 1/2" x 1/2"	73.0 x 21.3mm	730AT25051	\$33.56	730AT25052	\$43.44
	2 1/2" x 3/4"	73.0 x 26.7mm	730AT25071	\$33.54	730AT25072	\$43.44
	2 1/2" x 1"	73.0 x 33.4mm	730AT25101	\$43.30	730AT25102	\$56.05
	2 1/2" x 1 1/4"	73.0 x 42.4mm	730AT25121	\$43.27	730AT25122	\$56.05
	2 1/2" x 1 1/2"	73.0 x 48.3mm	730AT25151	\$43.27	730AT25152	\$56.05
	2 1/2" x 2"	73.0 x 60.3mm	730MT25201	\$38.53	730MT25202	\$46.93
	76.1 x 21.3mm	76.1 x 21.3mm	730AT26051	\$33.56	730AT26052	\$43.44
	76.1 x 26.7mm	76.1 x 26.7mm	730AT26071	\$33.54	730AT26072	\$43.44
	76.1 x 33.4mm	76.1 x 33.4mm	730AT26101	\$43.27	730AT26102	\$56.05
	76.1 x 42.4mm	76.1 x 42.4mm	730MT26121	\$43.27	730MT26122	\$56.05
	76.1 x 48.3mm	76.1 x 48.3mm	730MT26151	\$43.27	730MT26152	\$56.05
	76.1 x 60.3mm	76.1 x 60.3mm	730MT26201	\$38.53	730MT26202	\$46.93
	3" x 1/2"	88.9 x 21.3mm	730MT30051	\$35.22	730MT30052	\$45.63
	3" x 3/4"	88.9 x 26.7mm	730MT30071	\$35.22	730MT30072	\$45.63
	3" x 1"	88.9 x 33.4mm	730MT30101	\$43.27	730MT30102	\$56.05
	3" x 1 1/4"	88.9 x 42.4mm	730MT30121	\$43.27	730MT30122	\$56.05
	3" x 1 1/2"	88.9 x 48.3mm	730MT30151	\$43.27	730MT30152	\$56.05
	3" x 2"	88.9 x 60.3mm	730MT30201	\$43.27	730MT30202	\$56.05
	4" x 1/2"	114.3 x 21.3mm	730MT42051	\$50.73	730MT42052	\$65.74
	4" x 3/4"	114.3 x 26.7mm	730MT42071	\$50.73	730MT42072	\$65.74
	4" x 1"	114.3 x 33.4mm	730MT42101	\$50.73	730MT42102	\$65.74
	4" x 1 1/4"	114.3 x 42.4mm	730AT42121	\$50.73	730AT42122	\$65.74
	4" x 1 1/2"	114.3 x 48.3mm	730AT42151	\$50.73	730AT42152	\$65.74
	4" x 2"	114.3 x 60.3mm	730MT42201	\$52.36	730MT42202	\$67.89
	4" x 2 1/2"	114.3 x 73.0mm	7304025ES	\$52.36	7304025EGS	\$67.89
	4" x 76.1mm	114.3 x 76.1mm	730MT42261	\$52.36	730MT42262	\$67.89
	4" x 3"	114.3 x 88.9mm	730MT42301	\$52.36	730MT42302	\$67.89
5" x 1 1/2"	141.3 x 48.3mm	730MT53151	\$63.23	730MT53152	\$81.94	
5" x 2"	141.3 x 60.3mm	730MT53201	\$63.23	730MT53202	\$81.94	
5" x 2 1/2"	141.3 x 73.0mm	730MT53261	\$63.23	730MT53262	\$81.94	
5" x 3"	141.3 x 88.9mm	730MT53301	\$63.23	730MT53302	\$81.94	

Introduction
 Couplings & Fittings
 Mechanical Tees
 Valves
 Circuit Balancing Valves
 Accessories
 Copper Systems
 Stainless Steel Systems
 Plain End Systems
 HDPE Systems
 G-MINE PVC Systems
 Gaskets & Spare Parts
 Preparation Equipment
 Miscellaneous
 Indexes

**#730 Mechanical Tee – Threaded
 with Grade “E” Gasket**

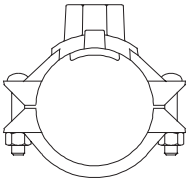
	<i>Pipe Size</i>		<i>Painted</i>		<i>Galvanized</i>	
	<i>Nominal Size</i>	<i>Outside Diameter</i>	<i>Grade “E” EPDM</i>	<i>List Price</i>	<i>Grade “E” EPDM</i>	<i>List Price</i>
	165.1 x 42.4mm	165.1 x 42.4mm	730MT62121	\$61.79	730MT62122	\$79.73
	165.1 x 48.3mm	165.1 x 48.3mm	730AT62151	\$66.35	730AT62152	\$85.92
	165.1 x 60.3mm	165.1 x 60.3mm	730AT62201	\$66.35	730AT62202	\$85.92
	165.1 x 73.1mm	165.1 x 73.1mm	730AT62261	\$66.35	730AT62262	\$85.92
	165.1 x 88.9mm	165.1 x 88.9mm	730AT62301	\$79.83	730AT62302	\$103.46
	6" x 1 1/4"	168.3 x 42.4mm	730MT63121	\$66.35	730MT63122	\$85.92
	6" x 1 1/2"	168.3 x 48.3mm	730AT63151	\$66.35	730AT63152	\$85.92
	6" x 2"	168.3 x 60.3mm	730AT63201	\$66.35	730AT63202	\$85.92
	6" x 2 1/2"	168.3 x 73.0mm	7306025ES	\$66.35	7306025EGS	\$85.92
	6" x 3"	168.3 x 88.9mm	730AT63301	\$66.35	730AT63302	\$85.92
	6" x 4"	168.3 x 114.3mm	7306040ES	\$96.58	7306040EGS	\$125.07
	8" x 2 1/2"	219.1 x 73.0mm	7308025ES	\$96.58	7308025EGS	\$125.07
	8" x 3"	219.1 x 88.9mm	7308030ES	\$149.80	7308030EGS	\$194.15
	8" x 4"	219.1 x 114.3mm	7308040ES	\$170.58	7308040EGS	\$221.14

Notes

For price and availability for the tee with Grade “T” Nitrile gaskets, contact GRINNELL Mechanical Products.

 Orders for items in shaded areas *cannot* be cancelled or returned.

Technical Data Sheet: G210

**#730 Mechanical Tee – Grooved
 with Grade “E” Gasket**

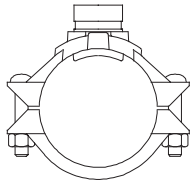

	Pipe Size		Painted		Galvanized	
	Nominal Size	Outside Diameter	Grade “E” EPDM	List Price	Grade “E” EPDM	List Price
	2" x 1/4"	60.3 x 42.4mm	730AG20121	\$35.36	730AG20122	\$45.82
	2" x 1/2"	60.3 x 48.3mm	730AG20151	\$35.36	730AG20152	\$45.82
	2 1/2" x 1/4"	73.0 x 42.4mm	730AG25121	\$43.27	730AG25122	\$56.05
	2 1/2" x 1/2"	73.0 x 48.3mm	730AG25151	\$43.27	730AG25152	\$56.05
	2 1/2" x 2"	73.0 x 60.3mm	7302520ERP	\$43.27	7302520EGRP	\$56.05
	76.1 x 42.4mm	76.1 x 42.4mm	730MG26121	\$43.27	730MG26122	\$56.05
	76.1 x 48.3mm	76.1 x 48.3mm	730MG26151	\$43.27	730MG26152	\$56.05
	76.1 x 60.3mm	76.1 x 60.3mm	730MG26201	\$43.27	730MG26202	\$56.05
	3" x 1/4"	88.9 x 42.4mm	730MG30121	\$43.27	730MG30122	\$56.05
	3" x 1/2"	88.9 x 48.3mm	730MG30151	\$43.27	730MG30152	\$56.05
	3" x 2"	88.9 x 60.3mm	730MG30201	\$43.27	730MG30202	\$56.05
	4" x 1/4"	114.3 x 42.4mm	730AG42121	\$50.73	730AG42122	\$65.74
	4" x 1/2"	114.3 x 48.3mm	730AG42151	\$50.73	730AG42152	\$65.74
	4" x 2"	114.3 x 60.3mm	730MG42201	\$52.36	730MG42202	\$67.89
	4" x 2 1/2"	114.3 x 73.0mm	730MG42251	\$52.36	730MG42252	\$67.89
	4" x 76.1mm	114.3 x 76.1mm	730MG42261	\$52.36	730MG42262	\$67.89
	4" x 3"	114.3 x 88.9mm	730MG42301	\$52.36	730MG42302	\$67.89
	5" x 1/2"	141.3 x 48.3mm	730MG53151	\$63.23	730MG53152	\$81.94
	5" x 2"	141.3 x 60.3mm	730MG53201	\$63.23	730MG53202	\$81.94
	5" x 2 1/2"	141.3 x 73.0mm	730MG53251	\$63.23	730MG53252	\$81.94
	5" x 76.1mm	141.3 x 76.1mm	730MG53261	\$63.23	730MG53262	\$81.94
	5" x 3"	141.3 x 88.9mm	730MG53301	\$63.23	730MG53302	\$81.94
	165.1 x 60.3mm	165.1 x 60.3mm	730AG62201	\$66.35	730AG62202	\$85.92
	165.1 x 73.0mm	165.1 x 73.0mm	730AG62251	\$66.35	730AG62252	\$85.92
	165.1 x 76.1mm	165.1 x 76.1mm	730AG62261	\$66.36	730AG62262	\$85.95
	165.1 x 88.9mm	165.1 x 88.9mm	730AG62301	\$79.83	730AG62302	\$103.46
	165.1 x 114.3mm	165.1 x 114.3mm	730AG6241	\$96.58	730AG6242	\$125.07
	6" x 1/4"	168.3 x 42.4mm	730MG63121	\$66.35	730MG63122	\$85.92
	6" x 1/2"	168.3 x 48.3mm	730AG63151	\$66.35	730AG63152	\$85.92
	6" x 2"	168.3 x 60.3mm	730AG63201	\$66.35	730AG63202	\$85.92
	6" x 2 1/2"	168.3 x 73.0mm	730AG63251	\$66.35	730AG63252	\$85.92
	6" x 76.1mm	168.3 x 76.1mm	730AG63261	\$66.35	730AG63262	\$85.92
	6" x 3"	168.3 x 88.9mm	730AG63301	\$66.35	730AG63302	\$85.92
	6" x 4"	168.3 x 114.3mm	730AG63421	\$96.58	730AG63422	\$125.07
	8" x 2 1/2"	219.1 x 73.0mm	7308025ERS	\$96.58	7308025EGRS	\$125.07
	8" x 76.1mm	219.1 x 76.1mm	730AG80261	\$96.58	730AG80262	\$125.07
	8" x 3"	219.1 x 88.9mm	730AG80301	\$149.80	730AG80302	\$194.15
	8" x 4"	219.1 x 114.3mm	730AG80421	\$170.58	730AG80422	\$221.14

Notes

For price and availability for the tee with Grade “T” Nitrile gaskets, contact GRINNELL Mechanical Products.

Orders for items in shaded areas *cannot* be cancelled or returned.

Technical Data Sheet: G210

Introduction
 Couplings & Fittings
 Mechanical Tees
 Valves
 Circuit Balancing Valves
 Accessories
 Copper Systems
 Stainless Steel Systems
 Plain End Systems
 HDPE Systems
 G-MINE PVC Systems
 Gaskets & Spare Parts
 Preparation Equipment
 Miscellaneous
 Indexes

**#730 Mechanical Cross – Threaded
 with Grade “E” Gasket**

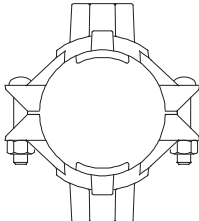
	<i>Pipe Size</i>		<i>Painted</i>		<i>Galvanized</i>	
	<i>Nominal Size</i>	<i>Outside Diameter</i>	<i>Grade “E” EPDM</i>	<i>List Price</i>	<i>Grade “E” EPDM</i>	<i>List Price</i>
	2" x 1 1/4"	60.3 x 42.4mm	7302013ECS	\$111.00	7302013EGCS	\$143.00
	2" x 1 1/2"	60.3 x 48.3mm	7302015ECS	\$111.00	7302015EGCS	\$143.00
	2 1/2" x 1 1/4"	73.0 x 42.4mm	7302513ECS	\$133.50	7302513EGCS	\$172.50
	2 1/2" x 1 1/2"	73.0 x 48.3mm	7302515ECS	\$133.50	7302515EGCS	\$143.00
	3" x 1 1/4"	88.9 x 42.4mm	7303013ECS	\$133.50	7303013EGCS	\$167.00
	3" x 1 1/2"	88.9 x 48.3mm	7303015ECS	\$133.50	7303015EGCS	\$167.00
	3" x 2"	88.9 x 60.3mm	7303020ECS	\$154.50	7303020EGCS	\$191.50
	4" x 1 1/4"	114.3 x 42.4mm	7304013ECS	\$162.00	7304013EGCS	\$203.50
	4" x 1 1/2"	114.3 x 48.3mm	7304015ECS	\$162.00	7304015EGCS	\$203.50
	4" x 2"	114.3 x 60.3mm	7304020ECS	\$173.50	7304020EGCS	\$205.00
	4" x 2 1/2"	114.3 x 73.0mm	7304025ECS	\$173.50	7304025EGCS	\$220.50
	4" x 3"	114.3 x 88.9mm	7304030ECS	\$181.00	7304030EGCS	\$234.00
	5" x 2"	141.3 x 60.3mm	7305020ECS	\$198.50	7305020EGCS	\$252.00
	5" x 2 1/2"	141.3 x 73.0mm	7305025ECS	\$209.00	7305025EGCS	\$267.00
	5" x 3"	141.3 x 88.9mm	7305030ECP	\$224.00	7305030EGCP	\$287.50
	6" x 1 1/2"	168.3 x 48.3mm	7306015ECS	\$203.00	7306015EGCS	\$261.50
	6" x 2"	168.3 x 60.3mm	7306020ECS	\$212.00	7306020EGCS	\$282.50
	6" x 2 1/2"	168.3 x 73.0mm	7306025ECS	\$218.50	7306025EGCS	\$282.50
	6" x 3"	168.3 x 88.9mm	7306030ECS	\$233.00	7306030EGCS	\$299.50
	6" x 4"	168.3 x 114.3mm	7306040ECS	\$258.00	7306040EGCS	\$335.50
8" x 2 1/2"	219.1 x 73.0mm	7308025ECS	\$357.00	7308025EGCS	\$451.00	
8" x 3"	219.1 x 88.9mm	7308030ECS	\$376.00	7308030EGCS	\$478.50	
8" x 4"	219.1 x 114.3mm	7308040ECS	\$388.50	7308040EGCS	\$502.50	

Notes

For price and availability for the cross with Grade “T” Nitrile gaskets, contact GRINNELL Mechanical Products.

 Orders for items in shaded areas *cannot* be cancelled or returned.

Technical Data Sheet: G210

**#730 Mechanical Cross – Grooved
 with Grade “E” Gasket**

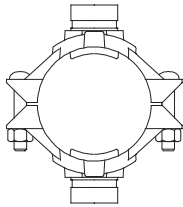

	Pipe Size		Painted		Galvanized	
	Nominal Size	Outside Diameter	Grade “E” EPDM	List Price	Grade “E” EPDM	List Price
	2" x 1 1/4"	60.3 x 42.4mm	7302013ERCS	\$111.00	7302013EGRCS	\$143.00
	2" x 1 1/2"	60.3 x 48.3mm	7302015ERCS	\$111.00	7302015EGRCS	\$143.00
	2 1/2" x 1 1/4"	73.0 x 42.4mm	7302513ERCS	\$133.50	7302513EGRCS	\$172.50
	2 1/2" x 1 1/2"	73.0 x 48.3mm	7302515ERCS	\$133.50	7302515EGRCS	\$143.00
	3" x 1 1/4"	88.9 x 42.4mm	7303013ERCS	\$133.50	7303013EGRCS	\$167.00
	3" x 1 1/2"	88.9 x 48.3mm	7303015ERCS	\$133.50	7303015EGRCS	\$167.00
	3" x 2"	88.9 x 60.3mm	7303020ERCS	\$154.50	7303020EGRCS	\$191.50
	4" x 1 1/4"	114.3 x 42.4mm	7304013ERCS	\$162.00	7304013EGRCS	\$203.50
	4" x 1 1/2"	114.3 x 48.3mm	7304015ERCS	\$162.00	7304015EGRCS	\$203.50
	4" x 2"	114.3 x 60.3mm	7304020ERCS	\$173.50	7304020EGRCS	\$205.00
	4" x 2 1/2"	114.3 x 73.0mm	7304025ERCS	\$173.50	7304025EGRCS	\$220.50
	4" x 3"	114.3 x 88.9mm	7304030ERCS	\$181.00	7304030EGRCS	\$234.00
	5" x 2"	141.3 x 60.3mm	7305020ERCS	\$198.50	7305020EGRCS	\$252.00
	5" x 2 1/2"	141.3 x 73.0mm	7305025ERCS	\$209.00	7305025EGRCS	\$267.00
	5" x 3"	141.3 x 88.9mm	7305030ERCS	\$224.00	7305030EGRCS	\$287.50
	6" x 1 1/2"	168.3 x 48.3mm	7306015ERCS	\$203.00	7306015EGRCS	\$261.50
	6" x 2"	168.3 x 60.3mm	7306020ERCS	\$212.00	7306020EGRCS	\$282.50
	6" x 2 1/2"	168.3 x 73.0mm	7306025ERCS	\$218.50	7306025EGRCS	\$282.50
	6" x 3"	168.3 x 88.9mm	7306030ERCS	\$233.00	7306030EGRCS	\$299.50
	6" x 4"	168.3 x 114.3mm	7306040ERCS	\$258.00	7306040EGRCS	\$335.50
	8" x 2 1/2"	219.1 x 73.0mm	7308025ERCS	\$357.00	7308025EGRCS	\$451.00
	8" x 3"	219.1 x 88.9mm	7308030ERCS	\$376.00	7308030EGRCS	\$478.50
	8" x 4"	219.1 x 114.3mm	7308040ERCS	\$388.50	7308040EGRCS	\$502.50

Notes

For price and availability for the cross with Grade “T” Nitrile gaskets, contact GRINNELL Mechanical Products.

Orders for items in shaded areas *cannot* be cancelled or returned.

Technical Data Sheet: G210

Introduction
 Couplings & Fittings
 Mechanical Tees
 Valves
 Circuit Balancing Valves
 Accessories
 Copper Systems
 Stainless Steel Systems
 Plain End Systems
 HDPE Systems
 G-MINE PVC Systems
 Gaskets & Spare Parts
 Preparation Equipment
 Miscellaneous
 Indexes

#B302 Grooved Butterfly Valve – EPDM

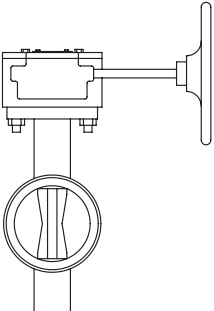
 <p>Available with Gear Operator and Handwheel (as pictured) or Lever Lock Handle. Specify choice when ordering.</p>	Pipe Size		Lever Lock Part Number		Gear Op. Part Number	
	Nominal Size	Outside Diameter	EPDM, w Lever	List Price	EPDM, with Gear Op.	List Price
	2"	60.3mm	B30220EL	\$399.92	B30220EG	\$863.60
	2½"	73.0mm	B30225EL	\$431.97	B30225EG	\$1,106.00
	3"	88.9mm	B30230EL	\$469.11	B30230EG	\$925.54
	4"	114.3mm	B30240EL	\$516.77	B30240EG	\$956.76
	5"	141.3mm	B30250EL	\$716.27	B30250EG	\$1,012.33
	6"	168.3mm	B30260EL	\$799.72	B30260EG	\$1,082.66
	8"	219.1mm	B30280EL	\$1,278.16	B30280EG	\$1,626.10
	10"	273.0mm	–	–	B30210EG	\$2,519.73
12"	323.9mm	–	–	B30212EG	\$2,839.54	

Notes

For price and availability for the valve with Grade "T" Nitrile, contact GRINNELL Mechanical Products.

 Orders for items in shaded areas **cannot** be cancelled or returned.

Technical Data Sheet: G310
#BN302 Grooved Butterfly Valve – EPDM
NSF Approved

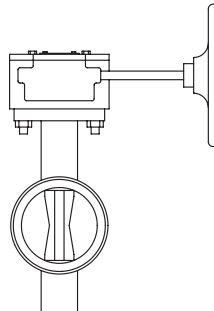
 <p>Available with Gear Operator and Handwheel (as pictured) or Lever Lock Handle. Specify choice when ordering.</p>	Pipe Size		Lever Handle		Gear Operator	
	Nominal Size	Outside Diameter	Part Number	List Price	Part Number	List Price
	2"	60.3mm	BN30220EL	\$559.00	BN30220EG	\$1,023.50
	2½"	73.0mm	BN30225EL	\$689.50	BN30225EG	\$895.45
	3"	88.9mm	BN30230EL	\$719.00	BN30230EG	\$1,182.00
	4"	114.3mm	BN30240EL	\$860.00	BN30240EG	\$1,323.00
	5"	141.3mm	BN30250EL	\$1,531.50	BN30250EG	\$1,995.50
	6"	168.3mm	BN30260EL	\$1,618.00	BN30260EG	\$2,062.00
	8"	219.1mm	BN30280EL	\$2,104.50	BN30280EG	\$2,548.00
	10"	273.0mm	–	–	BN30210EG	\$3,650.00
12"	323.9mm	–	–	BN30212EG	\$4,048.00	

Note

 Orders for items in shaded areas **cannot** be cancelled or returned.

Technical Data Sheet: G310

#B302 Grooved Butterfly Valve – Accessories

	Pipe Size		Description	Part Number	List Price
	Nominal Size	Outside Diameter			
	2"	60.3mm	Mechanical BFV Gear Operator 2" & Bushing	GOH30220	\$722.50
	2½"	73.0mm	Mechanical BFV Gear Operator 2½" & Bushing	GOH30225	\$722.50
	3"	88.9mm	Mechanical BFV Gear Operator 3" & Bushing	GOH30230	\$722.50
	4"	114.3mm	Mechanical BFV Gear Operator 4" & Bushing	GOH30240	\$722.50
	5"	141.3mm	Mechanical BFV Gear Operator 5" & Bushing	GOH30250	\$722.50
	6"	168.3mm	Mechanical BFV Gear Operator 6" & Bushing	GOH30260	\$722.50
	8"	219.1mm	Mechanical BFV Gear Operator 8" & Bushing	GOH30280	\$722.50
	10"	273.0mm	Mechanical BFV Gear Operator 10"	GOH30210	\$812.50
	12"	323.9mm	Mechanical BFV Gear Operator 12"	GOH30212	\$812.50
	2"	60.3mm	Mechanical BFV Lever Handle 2" & PLT	LH30220	\$167.00
	2½"	73.0mm	Mechanical BFV Lever Handle 2½" & PLT	LH30225	\$167.00
	3"	88.9mm	Mechanical BFV Lever Handle 3" & PLT	LH30230	\$167.00
	4"	114.3mm	Mechanical BFV Lever Handle 4" & PLT	LH30240	\$190.00
	5"	141.3mm	Mechanical BFV Lever Handle 5" & PLT	LH30250	\$190.00
	6"	168.3mm	Mechanical BFV Lever Handle 6" & PLT	LH30260	\$190.00
	8"	219.1mm	Mechanical BFV Lever Handle 8" & PLT	LH30280	\$190.00

Note

Orders for items in shaded areas **cannot** be cancelled or returned.

Technical Data Sheet: G310

**#B308 Grooved Butterfly Valve,
 EPDM – D.I. Nickel Plated, Gear Operator**

	Pipe Size		Part Number	List Price
	Nominal Size	Outside Diameter	EPDM	
	14"	355.6mm	B30814ENG	\$7,104.79
	16"	406.4mm	B30816ENG	\$7,868.95
	18"	457.2mm	B30818ENG	\$10,348.32
	20"	508.0mm	B30820ENG	\$12,183.11
	24"	609.6mm	B30824ENG	\$12,268.18
Model B308 Grooved Butterfly Valve – Option				
	Plain Shaft			POA
	Disc – 316 Stainless Steel			POA
	Disc – Bronze			POA
	Liner – Viton			POA

Notes

For price and availability for the valve with Grade "T" Nitrile, contact GRINNELL Mechanical Products.

Orders for items in shaded areas **cannot** be cancelled or returned.

Technical Data Sheet: G320

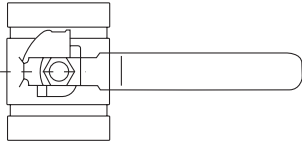
**#B8101 Low Profile Butterfly Valve
 with Lever Handle**

<i>Pipe Size</i>		<i>Part Number</i>	<i>List Price</i>
<i>Nominal Size</i>	<i>Outside Diameter</i>		
2"	60.3mm	B810120E	\$471.00
2½"	73.0mm	B810125E	\$598.50
3"	88.9mm	B810130E	\$676.00
4"	114.3mm	B810140E	\$743.50
5"	141.3mm	B810150E	\$1,417.50
6"	168.3mm	B810160E	\$1,500.00

Note

 Orders for items in shaded areas *cannot* be cancelled or returned.

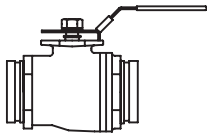
Technical Data Sheet: G330
BV835 Grooved Ball Valve

<i>Pipe Size</i>		<i>Lever Handle</i>		<i>Gear Operator</i>	
<i>Nominal Size</i>	<i>Outside Diameter</i>	<i>Part #</i>	<i>List Price</i>	<i>Part #</i>	<i>List Price</i>
1½"	48.3mm	BV83515	\$299.50	BV83515G	\$796.00
2"	60.3mm	BV83520	\$308.45	BV83520G	\$1,115.50
2½"	73.0mm	BV83525	\$568.20	BV83525G	\$1,464.50
3"	88.9mm	BV83530	\$641.55	BV83530G	\$2,074.50
4"	114.3mm	BV83540	\$2,053.86	BV83540G	\$2,643.00
6"	168.3mm	BV83560	\$3,546.43	BV83560G	\$6,235.00

Technical Data Sheet: G380

#590 Grooved Check Valve, EPDM

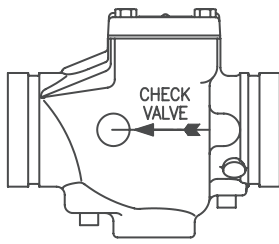
	Pipe Size		U.S. Part Number	List Price
	Nominal Size	Outside Diameter		
	2"	60.3mm	J59030020	\$331.97
	2½"	73.0mm	J59030025	\$492.13
	3"	88.9mm	J59030030	\$524.75
	4"	114.3mm	J59030040	\$549.23
	5"	141.3mm	J59030050	\$780.54
	6"	168.3mm	J59030060	\$826.07
	8"	219.1mm	J59030080	\$1,586.37
	10"	273.0mm	590300100	\$2,447.61
	12"	323.9mm	590300120	\$3,371.33
Notes				
For price and availability for the valve with Grade "T" Nitrile, contact GRINNELL Mechanical Products.				
Orders for items in shaded areas <i>cannot</i> be cancelled or returned.				
Technical Data Sheet: G350				

#CV-1 Grooved Check Valve, EPDM

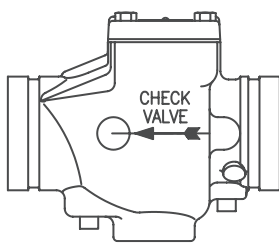
	Pipe Size		Part Number	List Price
	Nominal Size	Outside Diameter		
	2"	60.3mm	595900020	\$323.69
	2½"	73.0mm	595900025	\$311.80
	76.1mm	76.1mm	595900076	\$353.43
	3"	88.9mm	595900030	\$391.96
	4"	114.3mm	595900040	\$351.14
	139.7mm	139.7mm	595900139	\$585.82
	5"	141.3mm	595900050	\$565.31
	165.1mm	165.1mm	595900165	\$693.28
	6"	168.3mm	595900060	\$693.28
	8"	219.1mm	595900080	\$946.99
	10"	273.0mm	595900100	\$2,826.41
	12"	323.9mm	595900120	\$3,170.08
Notes				
For price and availability for the valve with Grade "T" Nitrile, contact GRINNELL Mechanical Products.				
Orders for items in shaded areas <i>cannot</i> be cancelled or returned.				
Technical Data Sheet: TFP1550				

Introduction
Couplings & Fittings
Mechanical Tees
Valves
Circuit Balancing Valves
Accessories
Copper Systems
Stainless Steel Systems
Plain End Systems
HDPE Systems
G-MINE PVC Systems
Gaskets & Spare Parts
Preparation Equipment
Miscellaneous
Indexes

#CV-1 Grooved Check Valve, Spare Parts

	<i>Pipe Size</i>		<i>Description</i>	<i>Part Number</i>	<i>List Price</i>
	<i>Nominal Size</i>	<i>Outside Diameter</i>			
	2"	60.3mm	CV-1 Clapper assembly	97670201	\$239,08
	2½"	73.0mm	CV-1 Clapper assembly, 2.5" & 76mm	97562801	\$190,31
	3"	88.9mm	CV-1 Clapper assembly	97562201	\$199,34
	4"	114.3mm	CV-1 Clapper assembly	97549001	\$256,69
	5"	141.3mm	CV-1 Clapper assembly, 5" & 139mm	97565501	\$329,38
	6"	168.3mm	CV-1 Clapper assembly, 6" & 165mm	97524101	\$446,97
	8"	219.1mm	CV-1 Clapper assembly	97592201	\$859,39
	10"	273.0mm	CV-1 Clapper assembly	97598001	\$895,43
	2"	60.3mm	CV-1 Seal Facing	59020EPDM	\$8,36
	2½"	73.0mm	CV-1 Seal Facing, 2.5" & 76mm	59025EPDM	\$6,63
	3"	88.9mm	CV-1 Seal Facing	59030EPDM	\$6,94
	4"	114.3mm	CV-1 Seal Facing	59040EPDM	\$7,23
	5"	141.3mm	CV-1 Seal Facing, 5" & 139mm	59050EPDM	\$14,18
	6"	168.3mm	CV-1 Seal Facing, 6" & 165mm	59060EPDM	\$16,88
	8"	219.1mm	CV-1 Seal Facing	59080EPDM	\$23,10
	10"	273.0mm	CV-1 Seal Facing	59010EPDM	\$26,71
	2"	60.3mm	CV-1 Gasket	97670501	\$25,93
	2½", 76.1mm & 3"	73.0, 76.1, 88.9mm	CV-1 Gasket	97561801	\$20,58
	4", 139.7mm & 5"	114.3, 139.7, & 141.3mm	CV-1 Gasket	97512001	\$39,76
	6" & 165mm	168.3 & 165.1mm	CV-1 Gasket	97521801	\$56,44
	8"	219.1mm	CV-1 Gasket	97547901	\$80,66
	10"	273.0mm	CV-1 Gasket	97600001	\$116,09

Technical Data Sheet: G310
#TD830, Triple Duty Valve, Flow Control Type

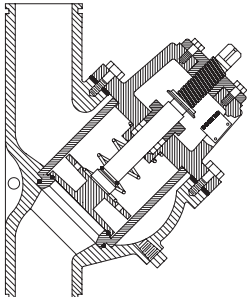
	<i>Pipe Size</i>		<i>Part Number</i>	<i>List Price</i>
	<i>Nominal Size</i>	<i>Outside Diameter</i>		
	2"	60.3mm	TD83020	\$2,741.00
	2½"	73.0mm	TD83025	\$2,777.00
	3"	88.9mm	TD83030	\$3,021.00
	4"	114.3mm	TD83040	\$4,141.50
	5"	141.3mm	TD83050	\$4,532.00
	6"	168.3mm	TD83060	\$6,783.50
	8"	219.1mm	TD83080	\$10,071.50
	10"	273.0mm	TD83010	\$16,817.50
	12"	323.9mm	TD83012	\$23,795.00
	14"	355.6mm	TD83014	\$36,723.00

Note

 Orders for items in shaded areas *cannot* be cancelled or returned.

Technical Data Sheet: G390

#CB800 Solder x Solder – Circuit Balancing Valve

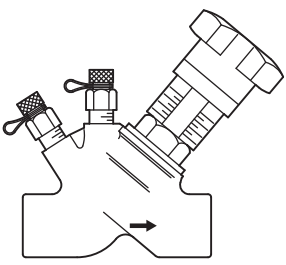
	Pipe Size		Part Number	List Price
	Nominal Size	Outside Diameter		
	1/2"	21.3mm	CB8000501	\$72.50
	3/4"	26.7mm	CB8000751	\$77.00
	1"	33.4mm	CB8001001	\$103.00
	1 1/4"	42.4mm	CB8001251	\$160.00
	1 1/2"	48.3mm	CB8001501	\$184.50
	2"	60.3mm	CB8002001	\$276.00
Note				
Orders for items in shaded areas <i>cannot</i> be cancelled or returned.				
Technical Data Sheet: G450				

#CB800 Thread x Thread – Circuit Balancing Valve

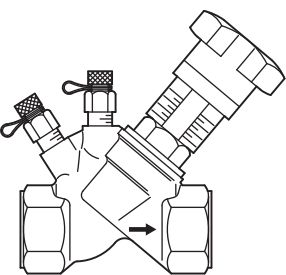
	Pipe Size		Part Number	List Price
	Nominal Size	Outside Diameter		
	1/2"	21.3mm	CB8005002	\$70.50
	3/4"	26.7mm	CB8000752	\$77.50
	1"	33.4mm	CB8001002	\$105.00
	1 1/4"	42.4mm	CB8001252	\$161.50
	1 1/2"	48.3mm	CB8001502	\$187.00
	2"	60.3mm	CB8002002	\$279.00
Note				
Orders for items in shaded areas <i>cannot</i> be cancelled or returned.				
Technical Data Sheet: G450				

Introduction
 Couplings & Fittings
 Mechanical Tees
 Valves
Circuit Balancing Valves
 Accessories
 Copper Systems
 Stainless Steel Systems
 Plain End Systems
 HDPE Systems
 G-MINE PVC Systems
 Gaskets & Spare Parts
 Preparation Equipment
 Miscellaneous
 Indexes

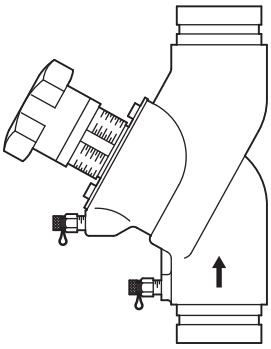

#CB800 Groove x Groove – Circuit Balancing Valve

	Pipe Size		Part Number	List Price
	Nominal Size	Outside Diameter		
	2 1/2"	73.0mm	CB8002504	\$602.50
	3"	88.9mm	CB8003004	\$937.50
	4"	114.3mm	CB8004004	\$1,296.00
	5"	141.3mm	CB8005004	\$2,345.00
	6"	168.3mm	CB8006004	\$3,141.50
	8"	219.1mm	CB8008004	\$6,693.50
	10"	273.0mm	CB8001104	\$8,782.50
	12"	323.9mm	CB8001204	\$19,085.00

Note

Orders for items in shaded areas **cannot** be cancelled or returned.

Technical Data Sheet: G450

#CB800 Flange x Flange – Circuit Balancing Valve

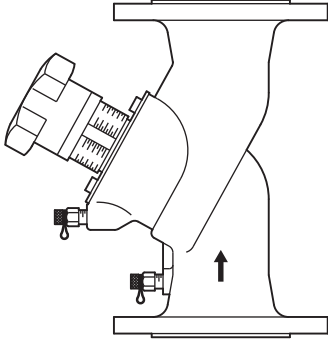
	Pipe Size		Part Number	List Price
	Nominal Size	Outside Diameter		
	2 1/2"	73.0mm	CB8002503	\$697.00
	3"	88.9mm	CB8003003	\$1,065.00
	4"	114.3mm	CB8004003	\$1,468.00
	5"	141.3mm	CB8005003	\$2,626.50
	6"	168.3mm	CB8006003	\$3,358.00
	8"	219.1mm	CB8008003	\$7,257.00
	10"	273.0mm	CB8001103	\$9,426.50
	12"	323.9mm	CB8001203	\$19,737.00

Note

Orders for items in shaded areas **cannot** be cancelled or returned.

Technical Data Sheet: G450

#CB800 Circuit Balancing Valves – Accessories

	Description	Part Number	List Price
	Fill & Drain Ball Valve 1/4"	CBBV025	\$50.50
	Set of Two Pressure Test Points	CBTP02	\$83.50
	Set of One Pressure Test Point & One Fill & Drain Ball Valve	CBTK02	\$91.50
	Stem Extension 3/8" – 2", 1.38"	CBSE7520	\$40.00
	Stem Extension 2 1/2" – 6", 1.38"	CBSE2560	\$45.50
	Hose BIB Kit	1659300	\$32.00
	CBV Needles	CBSR100	\$248.50
	Test Point Ext 80mm	CBTPX80	\$48.00
	Measuring Adapter	CBMA01	\$24.50

Note

Orders for items in shaded areas **cannot** be cancelled or returned.

Technical Data Sheet: G450

Insulation Kits for #CB800 Circuit Balancing Valves

	Pipe Size		Part Number	List Price
	Nominal Size	Outside Diameter		
	1/2"	21.3mm	CBIS050	\$20.50
	3/4"	26.7mm	CBIS075	\$20.50
	1"	33.4mm	CBIS010	\$22.50
	1 1/4"	42.4mm	CBIS125	\$25.00
	1 1/2"	48.3mm	CBIS150	\$28.00
	2"	60.3mm	CBIS200	\$33.50
	2 1/2"	73.0mm	CBIS250	\$392.00
	3"	88.9mm	CBIS300	\$436.50
	4"	114.3mm	CBIS400	\$485.00
	5"	141.3mm	CBIS500	\$541.50
	6"	168.3mm	CBIS600	\$668.50
8"	219.1mm	CBIS800	POA	

Note

Orders for items in shaded areas **cannot** be cancelled or returned.

Technical Data Sheet: G450

Differential Measuring Computer

	Description	Part Number	List Price
	Differential Measuring Computer	CBMDMC2	\$6,298.50

Note

Orders for items in shaded areas **cannot** be cancelled or returned.

Technical Data Sheet: G450

Introduction
 Couplings & Fittings
 Mechanical Tees
 Valves
 Circuit Balancing Valves
 Accessories
 Copper Systems
 Stainless Steel Systems
 Plain End Systems
 HDPE Systems
 G-MINE PVC Systems
 Gaskets & Spare Parts
 Preparation Equipment
 Miscellaneous
 Indexes

#S853 Grooved Wye Strainer

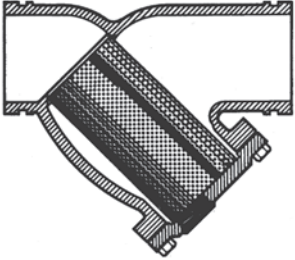
	Pipe Size		Painted		Galvanized	
	Nominal Size	Outside Diameter	Part Number	List Price	Part Number	List Price
	2"	60.3mm	S85320	\$273.74	S85320G	\$379.06
	2½"	73.0mm	S85325	\$304.42	S85325G	\$495.45
	3"	88.9mm	S85330	\$348.34	S85330G	\$516.69
	4"	114.3mm	S85340	\$495.37	S85340G	\$712.13
	5"	141.3mm	S85350	\$944.60	S85350G	\$2,574.00
	6"	168.3mm	S85360	\$1,311.57	S85360G	\$2,511.42
	8"	219.1mm	S85380	\$1,969.95	S85380G	\$4,841.16
	10"	273.0mm	S85310	\$2,834.87	S85310G	\$5,635.06
	12"	323.9mm	S85312	\$4,090.79	S85312G	\$6,560.17

Notes

Galvanized items have minimum order quantities of 10 pcs (2" thru 4") and 5 pcs (5" & larger) per line item or a small order charge of \$650.00 per line item will be assessed.

Orders for items in shaded areas **cannot** be cancelled or returned.

Technical Data Sheet: G420

#S855 Grooved Tee – Type Strainer

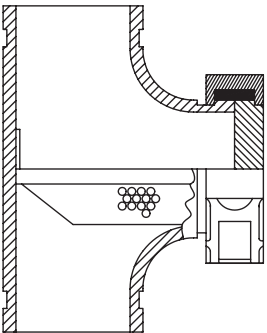
	Pipe Size		Painted		Galvanized	
	Nominal Size	Outside Diameter	Part Number	List Price	Part Number	List Price
	1½"	48.3mm	–	\$467.61	–	POA
	2"	60.3mm	S85520	\$522.92	S85520G	\$1,382.50
	2½"	73.0mm	S85525	\$558.96	S85525G	\$1,460.50
	3"	88.9mm	S85530	\$671.27	S85530G	\$1,665.00
	4"	114.3mm	S85540	\$802.18	S85540G	\$900.32
	5"	141.3mm	S85550	\$1,004.36	S85550G	\$2,300.45
	6"	168.3mm	S85560	\$1,390.24	S85560G	\$1,529.26
	8"	219.1mm	S85580	\$2,088.15	S85580G	\$2,871.78
	10"	273.0mm	S85510	\$2,964.83	S85510G	\$3,925.75
	12"	323.9mm	S85512	\$3,231.67	S85512G	\$4,931.51

Notes

Galvanized items have minimum order quantities of 10 pcs (2" thru 4") and 5 pcs (5" & larger) per line item or a small order charge of \$650.00 per line item will be assessed.

Orders for items in shaded areas **cannot** be cancelled or returned.

Technical Data Sheet: G430

#S810 Groove x Flange ANSI – Suction Diffuser

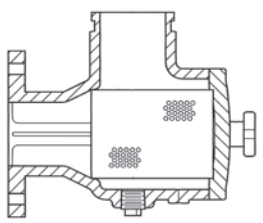
	Pipe Size		Part Number	List Price
	Nominal Size	Outside Diameter		
	3" x 2"	88.9 x 60.3mm	S8103020	\$2,396.01
	3" x 2 1/2"	88.9 x 73.0mm	S8103025	\$2,447.32
	3" x 3"	88.9 x 88.9mm	S8103030	\$2,447.32
	4" x 2"	114.3 x 60.3mm	S8104020	POA
	4" x 2 1/2"	114.3 x 73.0mm	S8104025	\$1,916.50
	4" x 3"	114.3 x 88.9mm	S8104030	\$2,510.77
	4" x 4"	114.3 x 114.3mm	S8104040	\$2,394.50
	5" x 3"	141.3 x 88.9mm	S8105030	\$3,352.00
	5" x 4"	141.3 x 114.3mm	S8105040	\$2,669.00
	5" x 5"	141.3 x 141.3mm	S8105050	\$2,803.50
	6" x 3"	168.3 x 88.9mm	S8106030	POA
	6" x 4"	168.3 x 114.3mm	S8106040	\$2,845.50
	6" x 5"	168.3 x 141.3mm	S8106050	\$3,403.00
	6" x 6"	168.3 x 168.3mm	S8106060	\$3,534.00
	8" x 5"	219.1 x 141.3mm	S8108050	\$3,625.00
	8" x 6"	219.1 x 168.3mm	S8108060	\$3,821.50
	8" x 8"	219.1 x 219.1mm	S8108080	\$7,042.99
	10" x 6"	273.0 x 168.3mm	S8101060	\$6,827.50
	10" x 8"	273.0 x 219.1mm	S8101080	\$7,947.14
	10" x 10"	273.0 x 273.0mm	S8101010	\$9,576.43
12" x 8"	323.9 x 219.1mm	S8101280	\$10,286.92	
12" x 10"	323.9 x 273.0mm	S8101210	\$11,335.43	
12" x 12"	323.9 x 323.9mm	S8101212	\$15,767.03	
14" x 10"	355.6 x 273.0mm	S8101410	\$4,754.83	
14" x 12"	355.6 x 323.9mm	S8101412	\$7,896.22	
14" x 14"	355.6 x 355.6mm	S8101414	\$12,092.91	
16" x 14"	406.4 x 355.6mm	S8101614	\$17,120.00	

Note

Orders for items in shaded areas **cannot** be cancelled or returned.

Technical Data Sheet: G410

Introduction
 Couplings & Fittings
 Mechanical Tees
 Valves
 Circuit Balancing Valves
Accessories
 Copper Systems
 Stainless Steel Systems
 Plain End Systems
 HDPE Systems
 G-MINE PVC Systems
 Gaskets & Spare Parts
 Preparation Equipment
 Miscellaneous
 Indexes

#640 Pivot-Bolt Rigid Couplings
with Grade “EHT” EPDM Center-Stop Push-On Style Gasket

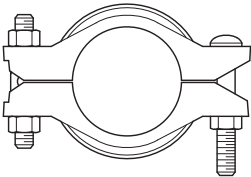
	Pipe Size		Part Number	List Price
	Nominal Size	Outside Diameter		
	2"	54.0mm	64020EHT	\$43.00
	2½"	66.7mm	64025EHT	\$49.00
	3"	79.4mm	64030EHT	\$54.50
	4"	104.8mm	64040EHT	\$82.00
	5"	130.7mm	64050EHT	\$139.00
	6"	155.6mm	64060EHT	\$183.50
	8"	206.4mm	64080EHT	\$285.00

Note

 Orders for items in shaded areas *cannot* be cancelled or returned.

Technical Data Sheet: G512
#672 Rigid Couplings
with Grade “EN” Tri-Seal Gasket

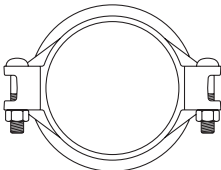
	Pipe Size		Part Number	List Price
	Nominal Size	Outside Diameter		
	2"	54.0mm	67220EN3	\$43.00
	2½"	66.7mm	67225EN3	\$49.00
	3"	79.4mm	67230EN3	\$54.50
	4"	104.8mm	67240EN3	\$82.00
	5"	130.7mm	67250EN3	\$139.00
	6"	155.6mm	67260EN3	\$183.50
	8"	206.4mm	67280EN3	\$285.00

Note

 Orders for items in shaded areas *cannot* be cancelled or returned.

Technical Data Sheet: G510
#61 Flange Adapter
with Grade “EN” EPDM Gasket

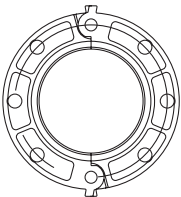
	Pipe Size		Part Number	List Price
	Nominal Size	Outside Diameter		
	2"	54.0mm	6120EN	\$333.00
	2½"	66.7mm	6125EN	\$346.50
	3"	79.4mm	6130EN	\$363.00
	4"	104.8mm	6140EN	\$398.50
	5"	130.7mm	6150EN	\$536.00
	6"	155.6mm	6160EN	\$583.00

Note

 Orders for items in shaded areas *cannot* be cancelled or returned.

Technical Data Sheet: G515

#610 Grooved 90° Elbow				
	<i>Pipe Size</i>		<i>Part Number</i>	<i>List Price</i>
	<i>Nominal Size</i>	<i>Outside Diameter</i>		
	2"	54.0mm	61020S	\$76.00
	2½"	66.7mm	61025S	\$82.50
	3"	79.4mm	61030S	\$116.50
	4"	104.8mm	61040S	\$268.50
	5"	130.7mm	61050S	\$762.50
	6"	155.6mm	61060S	\$1,217.00
	8"	206.4mm	61080S	\$2,286.00
Note				
Orders for items in shaded areas <i>cannot</i> be cancelled or returned.				
Technical Data Sheet: G520				

#601 Grooved 45° Elbow				
	<i>Pipe Size</i>		<i>Part Number</i>	<i>List Price</i>
	<i>Nominal Size</i>	<i>Outside Diameter</i>		
	2"	54.0mm	64520S	\$76.00
	2½"	66.7mm	64525S	\$82.50
	3"	79.4mm	64530S	\$116.50
	4"	104.8mm	64540S	\$268.50
	5"	130.7mm	64550S	\$762.50
	6"	155.6mm	64560S	\$1,217.00
	8"	206.4mm	64580S	\$2,286.00
Note				
Orders for items in shaded areas <i>cannot</i> be cancelled or returned.				
Technical Data Sheet: G520				

#619 Tee				
	<i>Pipe Size</i>		<i>Part Number</i>	<i>List Price</i>
	<i>Nominal Size</i>	<i>Outside Diameter</i>		
	2"	54.0mm	61920S	\$126.00
	2½"	66.7mm	61925S	\$134.00
	3"	79.4mm	61930S	\$199.50
	4"	104.8mm	61940S	\$438.00
	5"	130.7mm	61950S	\$1,228.00
	6"	155.6mm	61960S	\$1,517.50
	8"	206.4mm	61980S	\$2,710.50
Note				
Orders for items in shaded areas <i>cannot</i> be cancelled or returned.				
Technical Data Sheet: G520				

Introduction
Couplings & Fittings
Mechanical Tees
Valves
Circuit Balancing Valves
Accessories
Copper Systems
Stainless Steel Systems
Plain End Systems
HDPE Systems
G-MINE PVC Systems
Gaskets & Spare Parts
Preparation Equipment
Miscellaneous
Indexes

#660 Cap

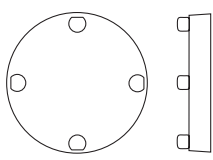
	Pipe Size		Part Number	List Price
	Nominal Size	Outside Diameter		
	2"	54.0mm	66020S	\$52.50
	2½"	66.7mm	66025S	\$78.00
	3"	79.4mm	66030S	\$97.50
	4"	104.8mm	66040S	\$146.50
	5"	130.7mm	66050S	\$165.00
	6"	155.6mm	66060S	\$300.00
	8"	206.4mm	66080S	POA

Note

 Orders for items in shaded areas *cannot* be cancelled or returned.

Technical Data Sheet: G520

#650 Grooved Concentric Reducer

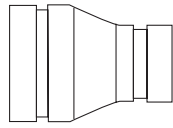
	Pipe Size		Part Number	List Price
	Nominal Size	Outside Diameter		
	2½" x 2"	66.7 x 54.0mm	6502520	\$110.00
	3" x 2"	79.4 x 54.0mm	6503020	\$110.00
	3" x 2½"	79.4 x 66.7mm	6503025	\$110.00
	4" x 2"	104.8 x 54.0mm	6504020	\$226.00
	4" x 2½"	104.8 x 66.7mm	6504025	\$226.00
	4" x 3"	104.8 x 79.4mm	6504030	\$226.00
	5" x 3"	130.7 x 79.4mm	6505030	\$637.50
	5" x 4"	130.7 x 104.8mm	6505040	\$637.50
	6" x 3"	155.6 x 79.4mm	6506030	\$690.00
	6" x 4"	155.6 x 104.8mm	6506040	\$690.00
	6" x 5"	155.6 x 130.7mm	6506050	\$690.00
	8" x 6"	206.4 x 155.6mm	6508060	\$1,211.50

Note

 Orders for items in shaded areas *cannot* be cancelled or returned.

Technical Data Sheet: G520

#652 Grooved Reducer Grooved x Cup

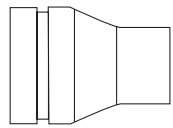
	Pipe Size		Part Number	List Price
	Nominal Size	Outside Diameter		
	2" x 1"	54.0 x 28.6mm	6522010W	\$91.00
	2" x 1¼"	54.0 x 34.9mm	6522013W	\$91.00
	2" x 1½"	54.0 x 41.3mm	6522015W	\$91.00
	2½" x 1"	66.7 x 28.6mm	6522510W	\$111.50
	2½" x 1¼"	66.7 x 34.9mm	6522513W	\$111.50
	2½" x 1½"	66.7 x 41.3mm	6522515W	\$111.50
	2½" x 2"	66.7 x 54.0mm	6522520W	\$111.50
	3" x 1½"	79.4 x 41.3mm	6523015W	\$138.50
	3" x 2"	79.4 x 54.0mm	6523020W	\$138.50
	4" x 2"	104.8 x 54.0mm	6524020W	\$258.00

Note

 Orders for items in shaded areas *cannot* be cancelled or returned.

Technical Data Sheet: G520

#621 Reducing Tee Grooved x Grooved x Grooved				
	<i>Pipe Size</i>		<i>Part Number</i>	<i>List Price</i>
	<i>Nominal Size</i>	<i>Outside Diameter</i>		
	2 1/2" x 2 1/2" x 2"	66.7 x 66.7 x 54.0mm	6212520	\$200.00
	3" x 3" x 2"	79.4 x 79.4 x 54.0mm	6213020	\$257.00
	3" x 3" x 2 1/2"	79.4 x 79.4 x 66.7mm	6213025	\$339.50
	4" x 4" x 2"	104.8 x 104.8 x 54.0mm	6214020	\$576.00
	4" x 4" x 2 1/2"	104.8 x 104.8 x 66.7mm	6214025	\$576.00
	4" x 4" x 3"	104.8 x 104.8 x 79.4mm	6214030	\$576.00
	5" x 5" x 3"	130.7 x 130.7 x 79.4mm	6215030	\$1,760.00
	5" x 5" x 4"	130.7 x 130.7 x 104.8mm	6215040	\$1,760.00
6" x 6" x 2 1/2"	155.6 x 155.6 x 66.7mm	6216025	\$2,149.50	
6" x 6" x 3"	155.6 x 155.6 x 79.4mm	6216030	\$2,149.50	
6" x 6" x 4"	155.6 x 155.6 x 104.8mm	6216040	\$2,149.50	
6" x 6" x 5"	155.6 x 155.6 x 130.7mm	6216050	\$2,149.50	
Note				
Orders for items in shaded areas <i>cannot</i> be cancelled or returned.				
Technical Data Sheet: G520				

#618 Reducing Tee Grooved x Grooved x Cup				
	<i>Pipe Size</i>		<i>Part Number</i>	<i>List Price</i>
	<i>Nominal Size</i>	<i>Outside Diameter</i>		
	2" x 2" x 3/4"	54.0 x 54.0 x 22.2mm	61820075	\$161.50
	2" x 2" x 1"	54.0 x 54.0 x 28.6mm	6182010	\$161.50
	2" x 2" x 1 1/4"	54.0 x 54.0 x 34.9mm	6182013	\$161.50
	2" x 2" x 1 1/2"	54.0 x 54.0 x 41.3mm	6182015	\$161.50
	2 1/2" x 2 1/2" x 3/4"	66.7 x 66.7 x 22.2mm	61825075	\$205.50
	2 1/2" x 2 1/2" x 1"	66.7 x 66.7 x 28.6mm	6182510	\$200.50
	2 1/2" x 2 1/2" x 1 1/4"	66.7 x 66.7 x 34.9mm	6182513	\$200.50
	2 1/2" x 2 1/2" x 1 1/2"	66.7 x 66.7 x 41.3mm	6182515	\$200.50
	3" x 3" x 3/4"	79.4 x 79.4 x 22.2mm	61830075	\$371.00
	3" x 3" x 1"	79.4 x 79.4 x 28.6mm	6183010	\$371.00
	3" x 3" x 1 1/4"	79.4 x 79.4 x 34.9mm	6183013	\$371.00
	3" x 3" x 1 1/2"	79.4 x 79.4 x 41.3mm	6183015	\$371.00
	4" x 4" x 3/4"	104.8 x 104.8 x 22.2mm	61840075	\$439.00
	4" x 4" x 1"	104.8 x 104.8 x 28.6mm	6184010	\$576.00
4" x 4" x 1 1/4"	104.8 x 104.8 x 34.9mm	6184013	\$576.00	
4" x 4" x 1 1/2"	104.8 x 104.8 x 41.3mm	6184015	\$576.00	
Note				
Orders for items in shaded areas <i>cannot</i> be cancelled or returned.				
Technical Data Sheet: G520				

Introduction
Couplings & Fittings
Mechanical Tees
Valves
Circuit Balancing Valves
Accessories
Copper Systems
Stainless Steel Systems
Plain End Systems
HDPE Systems
G-MINE PVC Systems
Gaskets & Spare Parts
Preparation Equipment
Miscellaneous
Indexes

**#407GG Dielectric Waterway Transition
 Fitting Grooved x Grooved, IPS x CTS**

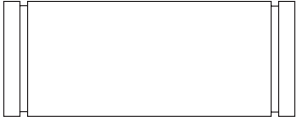
	<i>Pipe Size</i>		<i>Part Number</i>	<i>List Price</i>
	<i>Nominal Size</i>	<i>Outside Diameter</i>		
	2" x 4 ³ / ₁₆ " L	54.0mm	41480	\$133.00
	2 ¹ / ₂ " x 6 ³ / ₁₆ " L	66.7mm	41474	\$153.86
	3" x 6 ³ / ₁₆ " L	79.4mm	41475	\$229.00
	4" x 6 ³ / ₁₆ " L	104.8mm	41476	\$180.83
	5" x 6 ³ / ₁₆ " L	130.7mm	41477	\$513.00
	6" x 6 ³ / ₁₆ " L	155.6mm	41478	\$635.50

Note

 Orders for items in shaded areas *cannot* be cancelled or returned.

Technical Data Sheet: G180
**#407GT Dielectric Waterway
 Grooved x Thread**

	<i>Pipe Size</i>		<i>Part Number</i>	<i>List Price</i>
	<i>Nominal Size</i>	<i>Outside Diameter</i>		
	1" x 4" L	28.6mm	41465	\$49.50
	1 ¹ / ₄ " x 4" L	34.9mm	41466	\$52.14
	1 ¹ / ₂ " x 4" L	41.3mm	41467	\$60.25
	2" x 4" L	54.0mm	41468	\$139.75
	2 ¹ / ₂ " x 6" L	66.7mm	41469	\$153.86
	3" x 6" L	79.4mm	41470	\$167.98
	4" x 6" L	104.8mm	41472	\$180.83

Note

 Orders for items in shaded areas *cannot* be cancelled or returned.

Technical Data Sheet: G180

**#407T Dielectric Waterway
 Male Thread x Male Thread**

	Pipe Size		Part Number	List Price
	Nominal Size	Outside Diameter		
	1/2" x 3" L	15.9mm	41455	\$19.63
3/4" x 3" L	22.2mm	41456	\$24.31	
1" x 4" L	28.6mm	41457	\$38.60	
1 1/4" x 4" L	34.9mm	41458	\$52.14	
1 1/2" x 4" L	41.3mm	41459	\$60.25	
2" x 4" L	54.0mm	41460	\$139.75	
2 1/2" x 6" L	66.7mm	41461	\$153.86	
3" x 6" L	79.4mm	41462	\$191.00	
4" x 6" L	104.8mm	41464	\$256.00	

Note
 Orders for items in shaded areas *cannot* be cancelled or returned.

Technical Data Sheet: G180

**#B680 Copper System Butterfly Valve
 Grooved, EPDM, with Lever Handle or Gear Operated**

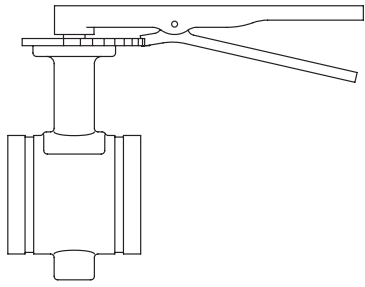
	Pipe Size		Lever Handle		Gear Operated	
	Nominal Size	Outside Diameter	Part Number	List Price	Part Number	List Price
	2"	54.0mm	68020EL	POA	68020EG	POA
2 1/2"	66.7mm	68025EL	\$748.00	68025EG	\$1,347.50	
3"	79.4mm	68030EL	\$821.50	68030EG	\$1,427.50	
4"	104.8mm	68040EL	\$1,039.50	68040EG	\$1,668.50	
5"	130.7mm	68050EL	\$1,322.00	68050EG	\$1,977.50	
6"	155.6mm	68060EL	\$1,413.00	68060EG	\$2,078.50	

Note
 Orders for items in shaded areas *cannot* be cancelled or returned.

Technical Data Sheet: G530

**Roll Groover Mini-Mite 2" – 8" Copper Tube
 #1039-66 Ratchet Hand Crank or Chucked into a Ridgid® 300**

	Pipe Size		Part Number	List Price
	Nominal Size	Outside Diameter		
	2" – 8"	60.3 - 219.1mm	41047	POA

Note
 Orders for items in shaded areas *cannot* be cancelled or returned.

Technical Data Sheet: G720

Introduction
 Couplings & Fittings
 Mechanical Tees
 Valves
 Circuit Balancing Valves
 Accessories
 Copper Systems
 Stainless Steel Systems
 Plain End Systems
 HDPE Systems
 G-MINE PVC Systems
 Gaskets & Spare Parts
 Preparation Equipment
 Miscellaneous
 Indexes



#472 Rigid Coupling 316 SS with Grade "EN" Gasket

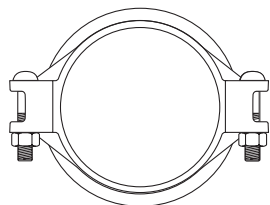

	Pipe Size		Part Number		List Price
	Nominal Size	Outside Diameter	European Part Number	U.S. Part Number	
	1 ¹ / ₄ "	42.4mm	472MD00424	47213EN	POA
	1 ¹ / ₂ "	48.3mm	472MD00484	47215EN	\$54.14
	2"	60.3mm	472MD00604	47220EN	\$63.23
	2 ¹ / ₂ "	73.0mm	472MD00734	47225EN	\$72.61
	76.1mm	76.1mm	472MD00764	—	\$72.61
	3"	88.9mm	472MD00894	47230EN	\$97.80
	4"	114.3mm	472MD01144	47240EN	\$141.83
	139.7mm	139.7mm	472MD01394	—	\$468.48
	5"	141.3mm	472MD01414	47250EN	POA
	6"	168.3mm	472MD01684	47260EN	\$560.01
	8"	219.1mm	472MD02194	47280EN	\$835.73
	10"	273.0mm	472MD02734	47210EN	\$1,096.56
	12"	323.9mm	472MD03244	47212EN	\$1,334.97

Notes

For price and availability for the couplings with Grade "T" Nitrile gaskets, contact GRINNELL Mechanical Products.

Orders for items in shaded areas **cannot** be cancelled or returned.

Technical Data Sheet: G560

#472 Rigid Coupling 316 SS with Grade "EN" Tri-Seal Gasket

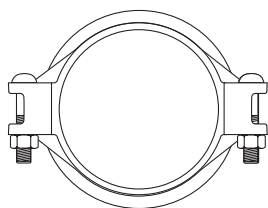

	Pipe Size		Part Number		List Price
	Nominal Size	Outside Diameter	European Part Number	U.S. Part Number	
	1 ¹ / ₄ "	42.4mm	—	47213EN3	POA
	1 ¹ / ₂ "	48.3mm	—	47215EN3	\$55.99
	2"	60.3mm	—	47220EN3	\$68.87
	2 ¹ / ₂ "	73.0mm	—	47225EN3	POA
	3"	88.9mm	—	47230EN3	\$103.24
	4"	114.3mm	—	47240EN3	\$142.77
	5"	141.3mm	—	47250EN3	POA
	6"	168.3mm	—	47260EN3	\$595.47
	8"	219.1mm	—	47280EN3	\$852.14
	10"	273.0mm	—	47210EN3	POA
	12"	323.9mm	—	47212EN3	POA

Notes

For price and availability for the couplings with Grade "T" Nitrile gaskets, contact GRINNELL Mechanical Products.

Orders for items in shaded areas **cannot** be cancelled or returned.

Technical Data Sheet: G560

**#405 Flexible Coupling 316 SS
 with Grade "EN" Gasket**

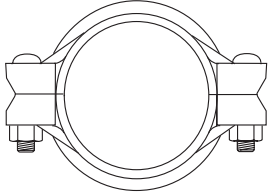
	Pipe Size		Part Number		List Price
	Nominal Size	Outside Diameter	European Part Number	U.S. Part Number	
	1"	33.4mm	405MD00344	40501EN	
1 1/4"	42.4mm	405MD00424	40513EN	\$72.20	
1 1/2"	48.3mm	405MD00484	40515EN	\$72.20	
2"	60.3mm	405MD00604	40520EN	\$72.20	
2 1/2"	73.0mm	405MD00734	40525EN	\$76.55	
76.1mm	76.1mm	405MD00764	—	\$76.55	
3"	88.9mm	405MD00894	40530EN	\$108.83	
4"	114.3mm	405MD01144	40540EN	\$145.74	
139.7mm	139.7mm	405MD01394	—	\$181.80	
5"	141.3mm	405MD01414	40550EN	POA	
6"	168.3mm	405MD01684	40560EN	POA	
8"	219.1mm	405MD02194	40580EN	POA	

Notes
 For price and availability for the couplings with Grade "T" Nitrile gaskets, contact GRINNELL Mechanical Products.
 Orders for items in shaded areas **cannot** be cancelled or returned.

Technical Data Sheet: G565

**#405 Flexible Coupling 316 SS
 with Grade "EN" Tri-Seal Gasket**

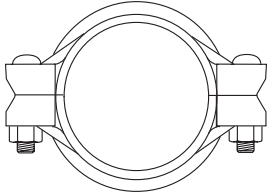
	Pipe Size		Part Number		List Price
	Nominal Size	Outside Diameter	European Part Number	U.S. Part Number	
	1 1/4"	42.4mm	—	40513EN3	
1 1/2"	48.3mm	—	40515EN3	\$74.07	
2"	60.3mm	—	40520EN3	POA	
2 1/2"	73.0mm	—	40525EN3	POA	
3"	88.9mm	—	40530EN3	\$117.42	
4"	114.3mm	—	40540EN3	\$157.20	
5"	141.3mm	—	40550EN3	POA	
6"	168.3mm	—	40560EN3	POA	
8"	219.1mm	—	40580EN3	POA	

Notes
 For price and availability for the couplings with Grade "T" Nitrile gaskets, contact GRINNELL Mechanical Products.
 Orders for items in shaded areas **cannot** be cancelled or returned.

Technical Data Sheet: G565

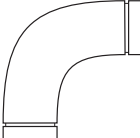

#410 90° Elbow 304 SS & 316 SS, Sch. 10

	Pipe Size		304 SS		316 SS	
	Nominal Size	Outside Diameter	Part Number	List Price	Part Number	List Price
	1"	33.4mm	410014A	POA	410016A	POA
	1 1/4"	42.4mm	410134A	POA	410136A	POA
	1 1/2"	48.3mm	410154A	POA	410156A	POA
	2"	60.3mm	410204A	POA	410206A	POA
	2 1/2"	73.0mm	410254A	POA	410256A	POA
	3"	88.9mm	410304A	POA	410306A	POA
	4"	114.3mm	410404A	POA	410406A	POA
	5"	141.3mm	410504A	POA	410506A	POA
	6"	168.3mm	410604A	POA	410606A	POA
	8"	219.1mm	410804A	POA	410806A	POA
	10"	273.0mm	410104A	POA	410106A	POA
	12"	323.9mm	410124A	POA	410126A	POA
Notes						
Schedule 40 fittings are available. Contact GRINNELL Mechanical Products for more information.						
Orders for items in shaded areas <i>cannot</i> be cancelled or returned.						
Technical Data Sheet: G570						

#401 45° Elbow, 304 SS & 316 SS, Sch. 10

	Pipe Size		304 SS		316 SS	
	Nominal Size	Outside Diameter	Part Number	List Price	Part Number	List Price
	1"	33.4mm	401014A	POA	401016A	POA
	1 1/4"	42.4mm	401134A	POA	401136A	POA
	1 1/2"	48.3mm	401154A	POA	401156A	POA
	2"	60.3mm	401204A	POA	401206A	POA
	2 1/2"	73.0mm	401254A	POA	401256A	POA
	3"	88.9mm	401304A	POA	401306A	POA
	4"	114.3mm	401404A	POA	401406A	POA
	5"	141.3mm	401504A	POA	401506A	POA
	6"	168.3mm	401604A	POA	401606A	POA
	8"	219.1mm	401804A	POA	401806A	POA
	10"	273.0mm	401104A	POA	401106A	POA
	12"	323.9mm	401124A	POA	401126A	POA
Notes						
Schedule 40 fittings are available. Contact GRINNELL Mechanical Products for more information.						
Orders for items in shaded areas <i>cannot</i> be cancelled or returned.						
Technical Data Sheet: G570						

See latest catalog or technical data sheets for specific approvals, listings, and design parameters.
POA = Price on availability. Prices subject to change without notice.

**#419 Tee,
 304 SS & 316 SS, Sch. 10**

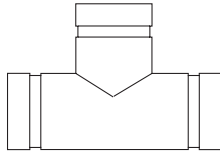

Pipe Size		304 SS		316 SS	
Nominal Size	Outside Diameter	Part Number	List Price	Part Number	List Price
1"	33.4mm	419014A	POA	419016A	POA
1 1/4"	42.4mm	419134A	POA	419136A	POA
1 1/2"	48.3mm	419154A	POA	419156A	POA
2"	60.3mm	419204A	POA	419206A	POA
2 1/2"	73.0mm	419254A	POA	419256A	POA
3"	88.9mm	419304A	POA	419306A	POA
4"	114.3mm	419404A	POA	419406A	POA
5"	141.3mm	419504A	POA	419506A	POA
6"	168.3mm	419604A	POA	419606A	POA
8"	219.1mm	419804A	POA	419806A	POA
10"	273.0mm	419104A	POA	419106A	POA
12"	323.9mm	419124A	POA	419126A	POA

Notes

Schedule 40 fittings are available. Contact GRINNELL Mechanical Products for more information.

Orders for items in shaded areas *cannot* be cancelled or returned.

Technical Data Sheet: G570

**#460 Cap,
 304 SS & 316 SS, Sch. 10**



Pipe Size		304 SS		316 SS	
Nominal Size	Outside Diameter	Part Number	List Price	Part Number	List Price
1"	33.4mm	460014A	POA	460016A	POA
1 1/4"	42.4mm	460134A	POA	460136A	POA
1 1/2"	48.3mm	460154A	POA	460156A	POA
2"	60.3mm	460204A	POA	460206A	POA
2 1/2"	73.0mm	460254A	POA	460256A	POA
3"	88.9mm	460304A	POA	460306A	POA
4"	114.3mm	460404A	POA	460406A	POA
5"	141.3mm	460504A	POA	460506A	POA
6"	168.3mm	460604A	POA	460606A	POA
8"	219.1mm	460804A	POA	460806A	POA
10"	273.0mm	460104A	POA	460106A	POA
12"	323.9mm	460124A	POA	460126A	POA

Note

Schedule 40 fittings are available. Contact GRINNELL Mechanical Products for more information.

Orders for items in shaded areas *cannot* be cancelled or returned.

Technical Data Sheet: G570

Introduction
 Couplings & Fittings
 Mechanical Tees
 Valves
 Circuit Balancing Valves
 Accessories
 Copper Systems
 Stainless Steel Systems
 Plain End Systems
 HDPE Systems
 G-MINE PVC Systems
 Gaskets & Spare Parts
 Preparation Equipment
 Miscellaneous
 Indexes



#421 Reducing Tee, 304 SS & 316 SS, Sch. 10

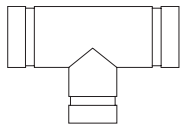

Pipe Size	304 SS		316 SS		
	Nominal Size	Outside Diameter	Part Number	List Price	Part Number
1 1/2" x 1 1/2" x 1"	48.3 x 48.3 x 33.4mm	42115014A	POA	42115016A	POA
1 1/2" x 1 1/2" x 1 1/4"	48.3 x 48.3 x 42.4mm	42115134A	POA	42115136A	POA
2" x 2" x 1"	60.3 x 60.3 x 33.4mm	42120014A	POA	42120016A	POA
2" x 2" x 1 1/4"	60.3 x 60.3 x 42.4mm	42120134A	POA	42120136A	POA
2" x 2" x 1 1/2"	60.3 x 60.3 x 48.3mm	42120154A	POA	42120156A	POA
2 1/2" x 2 1/2" x 1"	73.0 x 73.0 x 33.4mm	42125014A	POA	42125016A	POA
2 1/2" x 2 1/2" x 1 1/2"	73.0 x 73.0 x 48.3mm	42125154A	POA	42125156A	POA
2 1/2" x 2 1/2" x 2"	73.0 x 73.0 x 60.3mm	42125204A	POA	42125206A	POA
3" x 3" x 1"	88.9 x 88.9 x 33.4mm	42130014A	POA	42130016A	POA
3" x 3" x 1 1/4"	88.9 x 88.9 x 42.4mm	42130134A	POA	42130136A	POA
3" x 3" x 1 1/2"	88.9 x 88.9 x 48.3mm	42130154A	POA	42130156A	POA
3" x 3" x 2"	88.9 x 88.9 x 60.3mm	42130204A	POA	42130206A	POA
3" x 3" x 2 1/2"	88.9 x 88.9 x 73.0mm	42130254A	POA	42130256A	POA
3" x 3" x 76.1mm	88.9 x 88.9 x 76.1mm	-	POA	-	POA
4" x 4" x 2"	114.3 x 114.3 x 60.3mm	42140204A	POA	42140206A	POA
4" x 4" x 2 1/2"	114.3 x 114.3 x 73.0mm	42140254A	POA	42140256A	POA
4" x 4" x 76.1mm	114.3 x 114.3 x 76.1mm	-	POA	-	POA
4" x 4" x 3"	114.3 x 114.3 x 88.9mm	42140304A	POA	42140306A	POA
6" x 6" x 1 1/2"	168.3 x 168.3 x 48.3mm	42160154A	POA	42160156A	POA
6" x 6" x 2"	168.3 x 168.3 x 60.3mm	42160204A	POA	42160206A	POA
6" x 6" x 3"	168.3 x 168.3 x 88.9mm	42160304A	POA	42160306A	POA
6" x 6" x 4"	168.3 x 168.3 x 114.3mm	42160404A	POA	42160406A	POA
8" x 8" x 4"	219.1 x 219.1 x 114.3mm	42180404A	POA	42180406A	POA
8" x 8" x 6"	219.1 x 219.1 x 168.3mm	42180604A	POA	42180606A	POA
10" x 10" x 6"	273.0 x 273.0 x 168.3mm	42110604A	POA	42110606A	POA
10" x 10" x 8"	273.0 x 273.0 x 219.1mm	42110804A	POA	42110806A	POA
12" x 12" x 8"	323.9 x 323.9 x 219.1mm	42112804A	POA	42112806A	POA
12" x 12" x 10"	323.9 x 323.9 x 273.0mm	42112104A	POA	42112106A	POA

Note

Schedule 40 fittings are available. Contact GRINNELL Mechanical Products for more information.

Orders for items in shaded areas *cannot* be cancelled or returned.

Technical Data Sheet: G570

#441 Flange Adapter Nipple 150 lbs.
304 SS, Sch. 10

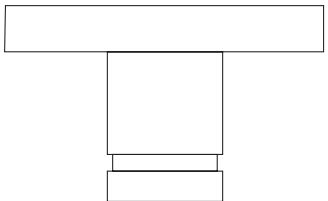
	Pipe Size		304 SS	
	Nominal Size	Outside Diameter	Part Number	List Price
	2"	60.3mm	441204	POA
2½"	73.0mm	441254	POA	
3"	88.9mm	441304	POA	
4"	114.3mm	441404	POA	
6"	168.3mm	441604	POA	
8"	219.1mm	441804	POA	

Notes
 Schedule 40 fittings are available. Contact GRINNELL Mechanical Products for more information.
 Orders for items in shaded areas **cannot** be cancelled or returned.

Technical Data Sheet: G568

#441 Flange Adapter Nipple PN16/PN10
304 SS, Sch. 10

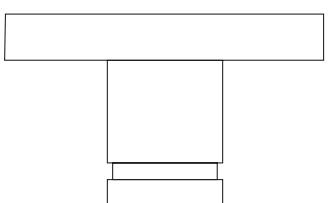
	Pipe Size		304 SS			
	Nominal Size	Outside Diameter	PN10		PN16	
			Part Number	List Price	Part Number	List Price
2"	60.3mm	—	POA	—	POA	
2½"	73.0mm	—	POA	—	POA	
76.1mm	76.1mm	—	POA	—	POA	
3"	88.9mm	—	POA	—	POA	
4"	114.3mm	—	POA	—	POA	
139.7mm	139.7mm	—	POA	—	POA	
5"	141.3mm	—	POA	—	POA	
6"	168.3mm	—	POA	—	POA	
8"	219.1mm	—	POA	—	POA	
10"	273.0mm	—	POA	—	POA	
12"	323.9mm	—	POA	—	POA	

Notes
 Schedule 40 and Type 316SS fittings are available. Contact GRINNELL Mechanical Products for more information.
 Contact GRINNELL Mechanical Products for more information on prices and part numbers.
 Orders for items in shaded areas **cannot** be cancelled or returned.

Technical Data Sheet: G570

Introduction
 Couplings & Fittings
 Mechanical Tees
 Valves
 Circuit Balancing Valves
 Accessories
 Copper Systems
 Stainless Steel Systems
 Plain End Systems
 HDPE Systems
 G-MINE PVC Systems
 Gaskets & Spare Parts
 Preparation Equipment
 Miscellaneous
 Indexes

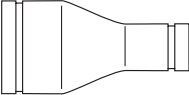

#450 Concentric Reducer, 304 SS & 316 SS, Sch. 10

	Pipe Size		304 SS		316 SS	
	Nominal Size	Outside Diameter	Part Number	List Price	Part Number	List Price
	1 1/2" x 1"	48.3 x 33.4mm	45015144A	POA	45015146A	POA
	1 1/2" x 1 1/4"	48.3 x 42.4mm	45015134A	POA	45015136A	POA
	2" x 1"	60.3 x 33.4mm	45020014A	POA	45020016A	POA
	2" x 1 1/4"	60.3 x 42.4mm	45020134A	POA	45020136A	POA
	2" x 1 1/2"	60.3 x 48.3mm	45020154A	POA	45020156A	POA
	2 1/2" x 1 1/2"	73.0 x 48.3mm	45025154A	POA	45025156A	POA
	2 1/2" x 2"	73.0 x 60.3mm	45025204A	POA	45025206A	POA
	3" x 1"	88.9 x 33.4mm	45030014A	POA	45030016A	POA
	3" x 1 1/4"	88.9 x 42.4mm	45030134A	POA	45030136A	POA
	3" x 1 1/2"	88.9 x 48.3mm	45030154A	POA	45030156A	POA
	3" x 2"	88.9 x 60.3mm	45030204A	POA	45030206A	POA
	3" x 2 1/2"	88.9 x 73.0mm	45030254A	POA	45030256A	POA
	3" x 76.1mm	88.9 x 76.1mm	–	POA	–	POA
	4" x 2"	114.3 x 60.3mm	45040204A	POA	45040206A	POA
	4" x 2 1/2"	114.3 x 73.0mm	45040254A	POA	45040256A	POA
	4" x 76.1mm	114.3 x 76.1mm	–	POA	–	POA
	4" x 3"	114.3 x 88.9mm	45040304A	POA	45040306A	POA
	5" x 3"	141.3 x 88.9mm	45050304A	POA	45050306A	POA
	5" x 4"	141.3 x 114.3mm	45050404A	POA	45050406A	POA
	6" x 2"	168.3 x 60.3mm	45060204A	POA	45060206A	POA
	6" x 2 1/2"	168.3 x 73.0mm	45060254A	POA	45060256A	POA
	6" x 3"	168.3 x 88.9mm	45060304A	POA	45060306A	POA
	6" x 4"	168.3 x 114.3mm	45060404A	POA	45060406A	POA
	6" x 139.7mm	168.3 x 139.7mm	–	POA	–	POA
	6" x 5"	168.3 x 141.3mm	45060504A	POA	45060506A	POA
	8" x 3"	219.1 x 88.9mm	45080304A	POA	45080306A	POA
	8" x 4"	219.1 x 114.3mm	45080404A	POA	45080406A	POA
	8" x 139.7mm	219.1 x 139.7mm	–	POA	–	POA
	8" x 6"	219.1 x 168.3mm	45080604A	POA	45080606A	POA
	10" x 4"	273.0 x 114.3mm	45010404A	POA	45010406A	POA
10" x 6"	273.0 x 168.3mm	45010604A	POA	45010606A	POA	
10" x 8"	273.0 x 219.1mm	45010804A	POA	45010806A	POA	
12" x 6"	323.9 x 168.3mm	45012604A	POA	45012606A	POA	
12" x 8"	323.9 x 219.1mm	45012804A	POA	45012806A	POA	
12" x 10"	323.9 x 273.0mm	45012104A	POA	45012106A	POA	

Notes

Schedule 40 fittings are available. Contact GRINNELL Mechanical Products for more information.

Orders for items in shaded areas **cannot** be cancelled or returned.

Technical Data Sheet: G570

**#451 Eccentric Reducer,
 304 SS & 316 SS, Sch. 10**

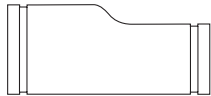

	Pipe Size		304 SS		316 SS	
	Nominal Size	Outside Diameter	Part Number	List Price	Part Number	List Price
	1 1/4" x 1"	42.4 x 33.4mm	45113014A	POA	45113014A	POA
	1 1/2" x 1"	48.3 x 33.4mm	45115014A	POA	45115014A	POA
	1 1/2" x 1 1/4"	48.3 x 42.4mm	45115134A	POA	45115134A	POA
	2" x 1"	60.3 x 33.4mm	45120014A	POA	45120014A	POA
	2" x 1 1/4"	60.3 x 42.4mm	45120134A	POA	45120134A	POA
	2" x 1 1/2"	60.3 x 48.3mm	45120154A	POA	45120154A	POA
	2 1/2" x 2"	73.0 x 60.3mm	45125204A	POA	45125204A	POA
	3" x 1"	88.9 x 33.4mm	45130014A	POA	45130014A	POA
	3" x 2"	88.9 x 60.3mm	45130204A	POA	45130204A	POA
	3" x 2 1/2"	88.9 x 73.0mm	45130254A	POA	45130254A	POA
	4" x 2"	114.3 x 60.3mm	45140204A	POA	45140204A	POA
	4" x 2 1/2"	114.3 x 73.0mm	45140254A	POA	45140254A	POA
	4" x 3"	114.3 x 88.9mm	45140304A	POA	45140304A	POA
	5" x 3"	141.3 x 88.9mm	45150304A	POA	45150304A	POA
	5" x 4"	141.3 x 114.3mm	45150404A	POA	45150404A	POA
	6" x 2"	168.3 x 60.3mm	45160204A	POA	45160204A	POA
	6" x 2 1/2"	168.3 x 73.0mm	45160254A	POA	45160254A	POA
	6" x 3"	168.3 x 88.9mm	45160304A	POA	45160304A	POA
	6" x 4"	168.3 x 114.3mm	45160404A	POA	45160404A	POA
	8" x 3"	219.1 x 88.9mm	45180304A	POA	45180304A	POA
	8" x 4"	219.1 x 114.3mm	45180404A	POA	45180404A	POA
	8" x 6"	219.1 x 168.3mm	45180604A	POA	45180604A	POA
	10" x 6"	273.0 x 168.3mm	45110604A	POA	45110604A	POA
	10" x 8"	273.0 x 219.1mm	45110804A	POA	45110804A	POA
	12" x 6"	323.9 x 168.3mm	45112604A	POA	45112604A	POA
	12" x 8"	323.9 x 219.1mm	45112804A	POA	45112804A	POA
	12" x 10"	323.9 x 273.0mm	45112104A	POA	45112104A	POA

Notes

Schedule 40 fittings are available. Contact GRINNELL Mechanical Products for more information.

Orders for items in shaded areas *cannot* be cancelled or returned.

Technical Data Sheet: G570

Introduction
 Couplings & Fittings
 Mechanical Tees
 Valves
 Circuit Balancing Valves
 Accessories
 Copper Systems
 Stainless Steel Systems
 Plain End Systems
 HDPE Systems
 G-MINE PVC Systems
 Gaskets & Spare Parts
 Preparation Equipment
 Miscellaneous
 Indexes

**#909 Plain End Coupling
 with Grade "E" EPDM Gasket**

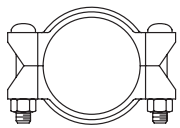
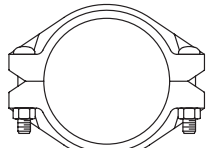
	Pipe Size		Painted		Galvanized	
	Nominal Size	Outside Diameter	Grade "E" EPDM Part No.	List Price	Grade "E" EPDM Part No.	List Price
 Fig. 909 – 2" thru 6"  Fig. 909 – 8" thru 18"	2"	60.3mm	909AE00601	\$89.22	909AE00602	\$113.75
	2½"	73.0mm	909AE00731	\$117.91	909AE00732	\$150.27
	3"	88.9mm	909AE00891	\$120.71	909AE00892	\$153.83
	4"	114.3mm	909AE01141	\$148.14	909AE01142	\$188.84
	6"	168.3mm	909AE01681	\$318.45	909AE01682	\$405.86
	8"	219.1mm	909AE02191	\$487.66	909AE02192	\$621.52
	10"	273.0mm	909AE02731	\$637.64	909AE02732	\$812.64
	12"	323.9mm	90912ES	\$709.77	90912EGS	\$887.23
	14"	355.6mm	90914ES	\$1,406.91	90914EGS	\$1,660.16
	16"	406.4mm	90916ES	\$1,543.99	90916EGS	\$1,821.97
	18"	457.2mm	90918ES	\$2,949.00	90918EGS	\$3,827.50

Notes

For price and availability for the couplings with Grade "T" Nitrile gaskets, contact GRINNELL Mechanical Products.

Orders for items in shaded areas *cannot* be cancelled or returned.

Technical Data Sheet: G190

#910 Plain End 90° Elbow

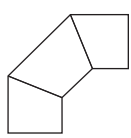
	Pipe Size		Painted		Galvanized	
	Nominal Size	Outside Diameter	Part Number	List Price	Part Number	List Price
	2"	60.3mm	91020F	\$407.00	91020GF	\$449.00
	2½"	73.0mm	91025F	\$476.50	91025GF	\$530.00
	3"	88.9mm	91030F	\$494.50	91030GF	\$553.50
	4"	114.3mm	91040F	\$560.50	91040GF	\$616.50
	6"	168.3mm	91060F	\$814.50	91060GF	\$991.50
	8"	219.1mm	91080F	\$1,530.50	91080GF	\$1,730.00
	10"	273.0mm	91010F	\$2,023.50	91010GF	\$2,264.00
	12"	323.9mm	91012F	\$2,251.00	91012GF	\$3,464.00

Note

Orders for items in shaded areas *cannot* be cancelled or returned.

Technical Data Sheet: G192

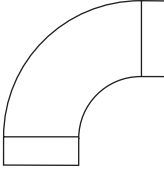
#910LR Plain End Long Radius 90° Elbow						
	<i>Pipe Size</i>		<i>Painted</i>		<i>Galvanized</i>	
	<i>Nominal Size</i>	<i>Outside Diameter</i>	<i>Part Number</i>	<i>List Price</i>	<i>Part Number</i>	<i>List Price</i>
	2"	60.3mm	91020LF	POA	91020LGF	POA
	2½"	73.0mm	91025LF	POA	91025LGF	POA
	3"	88.9mm	91030LF	POA	91030LGF	POA
	4"	114.3mm	91040LF	POA	91040LGF	POA
	6"	168.3mm	91060LF	POA	91060LGF	POA
	8"	219.1mm	91080LF	POA	91080LGF	POA
Note						
Orders for items in shaded areas <i>cannot</i> be cancelled or returned.						
Technical Data Sheet: G192						

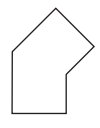
#901 Plain End 45° Elbow						
	<i>Pipe Size</i>		<i>Painted</i>		<i>Galvanized</i>	
	<i>Nominal Size</i>	<i>Outside Diameter</i>	<i>Part Number</i>	<i>List Price</i>	<i>Part Number</i>	<i>List Price</i>
	2"	60.3mm	90120F	\$431.50	90120GF	\$531.00
	2½"	73.0mm	90125F	\$431.50	90125GF	\$531.00
	3"	88.9mm	90130F	\$494.50	90130GF	\$557.00
	4"	114.3mm	90140F	\$515.50	90140GF	\$571.00
	6"	168.3mm	90160F	\$738.00	90160GF	\$867.00
	8"	219.1mm	90180F	\$865.50	90180GF	\$1,222.00
	10"	273.0mm	90110F	\$928.00	90110GF	\$1,161.00
12"	323.9mm	90112F	\$1,678.50	90112GF	\$1,976.50	
Note						
Orders for items in shaded areas <i>cannot</i> be cancelled or returned.						
Technical Data Sheet: G192						

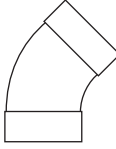
#901LR Plain End Long Radius 45° Elbow						
	<i>Pipe Size</i>		<i>Painted</i>		<i>Galvanized</i>	
	<i>Nominal Size</i>	<i>Outside Diameter</i>	<i>Part Number</i>	<i>List Price</i>	<i>Part Number</i>	<i>List Price</i>
	2"	60.3mm	90120LF	POA	90120LGF	POA
	2½"	73.0mm	90125LF	POA	90125LGF	POA
	3"	88.9mm	90130LF	POA	90130LGF	POA
	4"	114.3mm	90140LF	POA	90140LGF	POA
	6"	168.3mm	90160LF	POA	90160LGF	POA
	8"	219.1mm	90180LF	POA	90180LGF	POA
Note						
Orders for items in shaded areas <i>cannot</i> be cancelled or returned.						
Technical Data Sheet: G192						

Introduction
 Couplings & Fittings
 Mechanical Tees
 Valves
 Circuit Balancing Valves
 Accessories
 Copper Systems
 Stainless Steel Systems
 Plain End Systems
 HDPE Systems
 G-MINE PVC Systems
 Gaskets & Spare Parts
 Preparation Equipment
 Miscellaneous
 Indexes

#919 Plain End Tee

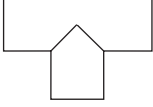
	Pipe Size		Painted		Galvanized	
	Nominal Size	Outside Diameter	Part Number	List Price	Part Number	List Price
	2"	60.3mm	91920F	\$332.00	91920GF	\$372.50
	2½"	73.0mm	91925F	\$433.00	91925GF	\$491.00
	3"	88.9mm	91930F	\$666.00	91930GF	\$761.00
	4"	114.3mm	91940F	\$954.00	91940GF	\$1,193.50
	6"	168.3mm	91960F	\$1,136.00	91960GF	\$1,304.00
	8"	219.1mm	91980F	\$1,637.50	91980GF	POA
	10"	273.0mm	91910F	POA	91910GF	POA
	12"	323.9mm	91912F	\$3,116.00	91912GF	POA

Note

 Orders for items in shaded areas *cannot* be cancelled or returned.

Technical Data Sheet: G192
#927 Plain End Cross

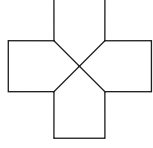
	Pipe Size		Painted		Galvanized	
	Nominal Size	Outside Diameter	Part Number	List Price	Part Number	List Price
	2"	60.3mm	92720F	POA	92720GF	POA
	2½"	73.0mm	92725F	POA	92725GF	POA
	3"	88.9mm	92730F	POA	92730GF	POA
	4"	114.3mm	92740F	POA	92740GF	POA
	6"	168.3mm	92760F	POA	92760GF	POA
	8"	219.1mm	92780F	POA	92780GF	POA
	10"	273.0mm	92710F	POA	92710GF	POA
	12"	323.9mm	92712F	POA	92712GF	POA

Note

 Orders for items in shaded areas *cannot* be cancelled or returned.

Technical Data Sheet: G192
#924 Plain End True Wye

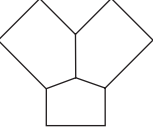
	Pipe Size		Painted		Galvanized	
	Nominal Size	Outside Diameter	Part Number	List Price	Part Number	List Price
	2"	60.3mm	92420F	POA	92420GF	POA
	2½"	73.0mm	92425F	POA	92425GF	POA
	3"	88.9mm	92430F	POA	92430GF	POA
	4"	114.3mm	92440F	POA	92440GF	POA
	6"	168.3mm	92460F	POA	92460GF	POA
	8"	219.1mm	92480F	POA	92480GF	POA
	10"	273.0mm	92410F	POA	92410GF	POA
	12"	323.9mm	92412F	POA	92412GF	POA

Note

 Orders for items in shaded areas *cannot* be cancelled or returned.

Technical Data Sheet: G192

#960 Plain End Cap (Bull Plug)

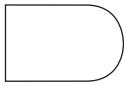
	Pipe Size		Painted		Galvanized	
	Nominal Size	Outside Diameter	Part Number	List Price	Part Number	List Price
	2"	60.3mm	96020F	\$232.50	96020GF	\$232.50
2 1/2"	73.0mm	96025F	\$232.50	96025GF	\$232.50	
3"	88.9mm	96030F	\$339.50	96030GF	\$288.63	
4"	114.3mm	96040F	\$438.00	96040GF	\$438.00	
6"	168.3mm	96060F	\$1,028.00	96060GF	\$1,028.00	
8"	219.1mm	96080F	\$1,931.00	96080GF	\$1,931.00	
10"	273.0mm	96010F	POA	96010GF	POA	
12"	323.9mm	96012F	\$5,384.50	96012GF	\$5,384.50	

Note

Orders for items in shaded areas *cannot* be cancelled or returned.

Technical Data Sheet: G192

#914 Plain End Lateral

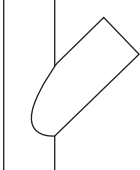
	Pipe Size		Painted		Galvanized	
	Nominal Size	Outside Diameter	Part Number	List Price	Part Number	List Price
	2"	60.3mm	91420F	\$449.00	91420GF	\$545.50
2 1/2"	73.0mm	91425F	\$516.50	91425GF	\$607.50	
3"	88.9mm	91430F	\$613.50	91430GF	\$721.00	
4"	114.3mm	91440F	\$844.50	91440GF	\$946.00	
6"	168.3mm	91460F	\$1,479.00	91460GF	\$1,794.50	
8"	219.1mm	91480F	\$2,482.00	91480GF	\$2,922.50	
10"	273.0mm	91410F	\$2,577.00	91410GF	\$4,508.00	
12"	323.9mm	91412F	\$4,738.00	91412GF	\$6,093.50	

Note

Orders for items in shaded areas *cannot* be cancelled or returned.

Technical Data Sheet: G192

Introduction
 Couplings & Fittings
 Mechanical Tees
 Valves
 Circuit Balancing Valves
 Accessories
 Copper Systems
 Stainless Steel Systems
 Plain End Systems
 HDPE Systems
 G-MINE PVC Systems
 Gaskets & Spare Parts
 Preparation Equipment
 Miscellaneous
 Indexes

#999 Plain End Swaged Nipple

	Pipe Size		Painted		Galvanized	
	Nominal Size	Outside Diameter	Part Number	List Price	Part Number	List Price
	2 1/2" x 2"	73.0 x 60.3mm	9992520F	POA	9992520GF	POA
	3" x 2"	88.9 x 60.3mm	9993020F	POA	9993020GF	POA
	3" x 2 1/2"	88.9 x 73.0mm	9993025F	POA	9993025GF	POA
	4" x 2"	114.3 x 60.3mm	9994020F	POA	9994020GF	POA
	4" x 2 1/2"	114.3 x 73.0mm	9994025F	POA	9994025GF	POA
	4" x 3"	114.3 x 88.9mm	9994030F	POA	9994030GF	POA
	5" x 2"	141.3 x 60.3mm	9995020F	POA	9995020GF	POA
	5" x 3"	141.3 x 88.9mm	9995030F	POA	9995030GF	POA
	5" x 4"	141.3 x 114.3mm	9995040F	POA	9995040GF	POA
	6" x 2"	168.3 x 60.3mm	9996020F	POA	9996020GF	POA
	6" x 2 1/2"	168.3 x 73.0mm	9996025F	POA	9996025GF	POA
	6" x 3"	168.3 x 88.9mm	9996030F	POA	9996030GF	POA
	6" x 4"	168.3 x 114.3mm	9996040F	POA	9996040GF	POA
	6" x 5"	168.3 x 141.3mm	9996050F	POA	9996050GF	POA
	8" x 3"	219.1 x 88.9mm	9998030F	POA	9998030GF	POA
	8" x 4"	219.1 x 114.3mm	9998040F	POA	9998040GF	POA
8" x 5"	219.1 x 141.3mm	9998050F	POA	9998050GF	POA	
8" x 6"	219.1 x 168.3mm	9998060F	POA	9998060GF	POA	

Note

 Orders for items in shaded areas *cannot* be cancelled or returned.

Technical Data Sheet: G192
#991 Adapter Nipple – Plain x Thread

	Pipe Size		Painted		Galvanized	
	Nominal Size	Outside Diameter	Part Number	List Price	Part Number	List Price
	2"	60.3mm	99120F	\$39.50	99120GF	\$46.00
	2 1/2"	73.0mm	99125F	\$42.09	99125GF	\$53.00
	3"	88.9mm	99130F	\$53.78	99130GF	\$65.00
	4"	114.3mm	99140F	\$94.04	99140GF	\$103.00
	6"	168.3mm	99160F	\$241.50	99160GF	\$285.50
	8"	219.1mm	99180F	POA	99180GF	POA

Note

 Orders for items in shaded areas *cannot* be cancelled or returned.

Technical Data Sheet: G192

#992 Adapter Nipple – Plain x Grooved						
	<i>Pipe Size</i>		<i>Painted</i>		<i>Galvanized</i>	
	<i>Nominal Size</i>	<i>Outside Diameter</i>	<i>Part Number</i>	<i>List Price</i>	<i>Part Number</i>	<i>List Price</i>
	2"	60.3mm	99220F	\$39.50	99220GF	POA
	2½"	73.0mm	99225F	\$42.09	99225GF	POA
	3"	88.9mm	99230F	\$53.78	99230GF	POA
	4"	114.3mm	99240F	\$94.04	99240GF	POA
	6"	168.3mm	99260F	\$241.50	99260GF	POA
8"	219.1mm	99280F	POA	99280GF	POA	
Note						
Orders for items in shaded areas <i>cannot</i> be cancelled or returned.						
Technical Data Sheet: G192						

#993 Adapter Nipple – Plain x Plain						
	<i>Pipe Size</i>		<i>Painted</i>		<i>Galvanized</i>	
	<i>Nominal Size</i>	<i>Outside Diameter</i>	<i>Part Number</i>	<i>List Price</i>	<i>Part Number</i>	<i>List Price</i>
	2"	60.3mm	99320F	\$39.50	99320GF	POA
	2½"	73.0mm	99325F	\$42.09	99325GF	POA
	3"	88.9mm	99330F	\$53.78	99330GF	POA
	4"	114.3mm	99340F	\$94.04	99340GF	POA
	6"	168.3mm	99360F	\$241.50	99360GF	POA
8"	219.1mm	99380F	POA	99380GF	POA	
Note						
Orders for items in shaded areas <i>cannot</i> be cancelled or returned.						
Technical Data Sheet: G192						

#941 Flange Adapter 150 lbs.						
	<i>Pipe Size</i>		<i>Painted</i>		<i>Galvanized</i>	
	<i>Nominal Size</i>	<i>Outside Diameter</i>	<i>Part Number</i>	<i>List Price</i>	<i>Part Number</i>	<i>List Price</i>
	2"	60.3mm	94120F	POA	94120GF	POA
	2½"	73.0mm	94125F	POA	94125GF	POA
	3"	88.9mm	94130F	POA	94130GF	POA
	4"	114.3mm	94140F	POA	94140GF	POA
	6"	168.3mm	94160F	POA	94160GF	POA
8"	219.1mm	94180F	POA	94180GF	POA	
Note						
Orders for items in shaded areas <i>cannot</i> be cancelled or returned.						
Technical Data Sheet: G192						

Introduction
Couplings & Fittings
Mechanical Tees
Valves
Circuit Balancing Valves
Accessories
Copper Systems
Stainless Steel Systems
Plain End Systems
HDPE Systems
G-MINE PVC Systems
Gaskets & Spare Parts
Preparation Equipment
Miscellaneous
Indexes

#942 Flange Adapter 300 lbs.

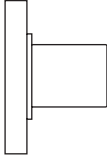
	Pipe Size		Painted		Galvanized	
	Nominal Size	Outside Diameter	Part Number	List Price	Part Number	List Price
	2"	60.3mm	94220F	POA	94220GF	POA
	2½"	73.0mm	94225F	POA	94225GF	POA
	3"	88.9mm	94230F	POA	94230GF	POA
	4"	114.3mm	94240F	POA	94240GF	POA
	6"	168.3mm	94260F	POA	94260GF	POA
	8"	219.1mm	94280F	POA	94280GF	POA

Note

 Orders for items in shaded areas *cannot* be cancelled or returned.

Technical Data Sheet: G192
#921 Reducing Tee Plain End

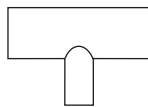
	Pipe Size		Painted		Galvanized	
	Nominal Size	Outside Diameter	Part Number	List Price	Part Number	List Price
	3" x 3" x 2"	88.9 x 88.9 x 60.3mm	9213020F	POA	9213020GF	\$662.50
	4" x 4" x 2"	114.3 x 114.3 x 60.3mm	9214020F	\$412.00	9214020GF	POA
	4" x 4" x 2½"	114.3 x 114.3 x 73.0mm	9214025F	\$424.00	9214025GF	POA
	4" x 4" x 3"	114.3 x 114.3 x 88.9mm	9214030F	\$424.00	9214030GF	POA
	6" x 6" x 2"	168.3 x 168.3 x 60.3mm	9216020F	POA	9216020GF	POA
	6" x 6" x 3"	168.3 x 168.3 x 88.9mm	9216030F	POA	9216030GF	POA
	6" x 6" x 4"	168.3 x 168.3 x 114.3mm	9216040F	POA	9216040GF	\$929.00
	8" x 8" x 2"	219.1 x 219.1 x 60.3mm	9218020F	POA	9218020GF	POA
	8" x 8" x 3"	219.1 x 219.1 x 88.9mm	9218030F	POA	9218030GF	POA
	8" x 8" x 4"	219.1 x 219.1 x 114.3mm	9218040F	\$820.50	9218040GF	POA
	8" x 8" x 6"	219.1 x 219.1 x 168.3mm	9218060F	\$961.50	9218060GF	POA
	10" x 10" x 4"	273.0 x 273.0 x 114.3mm	9211040F	POA	9211040GF	POA
	10" x 10" x 6"	273.0 x 273.0 x 168.3mm	9211060F	POA	9211060GF	POA
	10" x 10" x 8"	273.0 x 273.0 x 219.1mm	9211080F	POA	9211080GF	POA

Note

 Orders for items in shaded areas *cannot* be cancelled or returned.

Technical Data Sheet: G192

**#9094 HDPE Flange Coupling
 with Grade “E” EPDM Gasket**

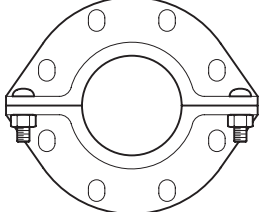
	Pipe Size		Part Number	List Price
	Nominal Size	Outside Diameter		
	4"	114.3mm	909440ES	\$442.52
	6"	168.3mm	909460ES	\$690.03
	8"	219.1mm	909480ES	\$1,117.71
Note				
Orders for items in shaded areas <i>cannot</i> be cancelled or returned.				
Technical Data Sheet: G584				

**#9095 HDPE Coupling
 with Grade “E” EPDM Gasket**

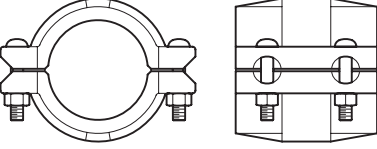
	Pipe Size		Part Number	List Price
	Nominal Size	Outside Diameter		
	2"	60.3mm	909520ES	\$93.72
	3"	88.9mm	909530ES	\$128.51
	4"	114.3mm	909540ES	\$192.78
	5"	141.3mm	909550ES	\$263.71
	6"	168.3mm	909560ES	\$284.45
	8"	219.1mm	909580ES	\$311.60
	10"	273.0mm	909510ES	\$520.05
	12"	323.9mm	909512ES	\$679.82
	14"	355.6mm	909514ES	\$2,819.00
	16"	406.4mm	909516ES	\$2,711.03
	18"	457.2mm	909518ES	\$4,609.50
	20"	508.0mm	909520ES	\$6,259.00
Note				
Orders for items in shaded areas <i>cannot</i> be cancelled or returned.				
Technical Data Sheet: G580				

#9097 HDPE Transition Coupling

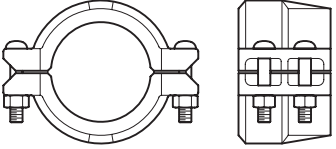
	Pipe Size		Part Number	List Price
	Nominal Size	Outside Diameter		
	2"	60.3mm	909720ES	\$94.79
	3"	88.9mm	909730ES	\$132.78
	4"	114.3mm	909740ES	\$190.89
	5"	141.3mm	909750ES	\$213.36
	6"	168.3mm	909760ES	\$241.72
	8"	219.1mm	909780ES	\$315.07
	10"	273.0mm	909710ES	\$403.84
	12"	323.9mm	909712ES	\$483.74
Note				
Orders for items in shaded areas <i>cannot</i> be cancelled or returned.				
Technical Data Sheet: G582				

Introduction
 Couplings & Fittings
 Mechanical Tees
 Valves
 Circuit Balancing Valves
 Accessories
 Copper Systems
 Stainless Steel Systems
 Plain End Systems
 HDPE Systems
 G-MINE PVC Systems
 Gaskets & Spare Parts
 Preparation Equipment
 Miscellaneous
 Indexes



#72900 SDR Pipe

	Pipe Size		Description	Part Number	List Price
	Nominal Size	Outside Diameter			
	2"	60.3mm	72900 2" SDR 17 Pipe	7290020	\$2.55
	3"	88.9mm	72900 3" SDR 17 Pipe	7290030	\$5.20
	4"	114.3mm	72900 4" SDR 21 Pipe	7290040L	\$7.00
	4"	114.3mm	72900 4" SDR 17 Pipe	7290040	\$8.45
	4"	114.3mm	72900 4" SDR 13.5 Pipe	7290040H	\$10.30
	6"	168.3mm	72900 6" SDR 21 Pipe	7290060L	\$13.60
	6"	168.3mm	72900 6" SDR 17 Pipe	7290060	\$16.80
	6"	168.3mm	72900 6" SDR 13.5 Pipe	7290060H	\$23.05
	8"	219.1mm	72900 8" SDR 21 Pipe	7290080L	\$24.00
	8"	219.1mm	72900 8" SDR 17 Pipe	7290080	\$29.55
	8"	219.1mm	72900 8" SDR 13.5 Pipe	7290080H	\$38.10
	10"	273.0mm	72900 10" SDR 26 Pipe	7290010	\$30.65
	12"	323.9mm	72900 12" SDR 26 Pipe	7290012	\$41.65

Note

Orders for items in shaded areas **cannot** be cancelled or returned.

Technical Data Sheet: G590

#72901 SDR Pipe with Coupling

	Pipe Size		Description	Part Number	List Price
	Nominal Size	Outside Diameter			
	2"	60.3mm	72901 2" SDR 17 Pipe with Coupling	7290120	\$3.55
	3"	88.9mm	72901 3" SDR 17 Pipe with Coupling	7290130	\$6.70
	4"	114.3mm	72901 4" SDR 21 Pipe with Coupling	7290140L	\$8.90
	4"	114.3mm	72901 4" SDR 17 Pipe with Coupling	7290140	\$10.40
	4"	114.3mm	72901 4" SDR 13.5 Pipe with Coupling	7290140H	\$13.35
	6"	168.3mm	72901 6" SDR 21 Pipe with Coupling	7290160L	\$16.60
	6"	168.3mm	72901 6" SDR 17 Pipe with Coupling	7290160	\$19.85
	6"	168.3mm	72901 6" SDR 13.5 Pipe with Coupling	7290160H	\$27.75
	8"	219.1mm	72901 8" SDR 21 Pipe with Coupling	7290180L	\$29.65
	8"	219.1mm	72901 8" SDR 17 Pipe with Coupling	7290180	\$36.15
	8"	219.1mm	72901 8" SDR 13.5 Pipe with Coupling	7290180H	\$45.70
	10"	273.0mm	72901 10" SDR 26 Pipe with Coupling	7290110	\$38.90
	12"	323.9mm	72901 12" SDR 26 Pipe with Coupling	7290112	\$52.60

Note

Orders for items in shaded areas **cannot** be cancelled or returned.

Technical Data Sheet: G590

G-MINE PVC Systems products have a 6 month warranty, contact GRINNELL Mechanical Products for additional information.
See latest catalog or technical data sheets for specific approvals, listings, and design parameters.
POA = Price on availability. Prices subject to change without notice.

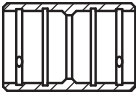
#72904 Coupling					
	<i>Pipe Size</i>		<i>Description</i>	<i>Part Number</i>	<i>List Price</i>
	<i>Nominal Size</i>	<i>Outside Diameter</i>			
	2"	60.3mm	72904 2" Coupling 250psi	7290420	\$21.50
	3"	88.9mm	72904 3" Coupling 250psi	7290430	\$31.00
	4"	114.3mm	72904 4" Coupling 250psi	7290440	\$39.50
	4"	114.3mm	72904 4" Coupling 350psi H	7290440H	\$62.00
	6"	168.3mm	72904 6" Coupling 250psi	7290460	\$60.50
	6"	168.3mm	72904 6" Coupling 350psi H	7290460H	\$94.50
	8"	219.1mm	72904 8" Coupling 250psi	7290480	\$114.00
	8"	219.1mm	72904 8" Coupling 350psi H	7290480H	\$152.00
10"	273.0mm	72904 10" Coupling 250psi	7290410	\$165.50	
12"	323.9mm	72904 12" Coupling 250psi	7290412	\$219.50	
Note					
Orders for items in shaded areas <i>cannot</i> be cancelled or returned.					
Technical Data Sheet: G590					

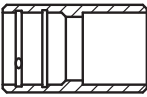
#72905 Spline x Solvent Weld Coupling					
	<i>Pipe Size</i>		<i>Description</i>	<i>Part Number</i>	<i>List Price</i>
	<i>Nominal Size</i>	<i>Outside Diameter</i>			
	2"	60.3mm	72905 2" Spline x Solvent Weld Coupling	7290520	\$19.00
	3"	88.9mm	72905 3" Spline x Solvent Weld Coupling	7290530	\$29.60
	4"	114.3mm	72905 4" Spline x Solvent Weld Coupling	7290540	\$38.14
	6"	168.3mm	72905 6" Spline x Solvent Weld Coupling	7290560	\$55.60
	8"	219.1mm	72905 8" Spline x Solvent Weld Coupling	7290580	\$96.80
	10"	273.0mm	72905 10" Spline x Solvent Weld Coupling	7290510	\$152.50
	12"	323.9mm	72905 12" Spline x Solvent Weld Coupling	7290512	\$199.00
Note					
Orders for items in shaded areas <i>cannot</i> be cancelled or returned.					
Technical Data Sheet: G590					

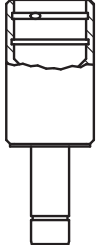
#72919 Male Thread x Female Thread Reducing Coupling					
	<i>Pipe Size</i>		<i>Description</i>	<i>Part Number</i>	<i>List Price</i>
	<i>Nominal Size</i>	<i>Outside Diameter</i>			
	4" x 2"	114.3 x 60.3mm	72919 4" x 2" Reducing Coupling Female Thread x Male Thread	729194020	\$139.08
	4" x 3"	114.3 x 88.9mm	72919 4" x 3" Reducing Coupling Female Thread x Male Thread	729194030	\$146.28
	6" x 2"	168.3 x 60.3mm	72919 6" x 2" Reducing Coupling Female Thread x Male Thread	729196020	\$303.12
	6" x 3"	168.3 x 88.9mm	72919 6" x 3" Reducing Coupling Female Thread x Male Thread	729196030	\$309.64
	6" x 4"	168.3 x 114.3mm	72919 6" x 4" Reducing Coupling Female Thread x Male Thread	729196040	\$312.00
	8" x 2"	219.1 x 60.3mm	72919 8" x 2" Reducing Coupling Female Thread x Male Thread	729198020	\$537.72
	8" x 4"	219.1 x 114.3mm	72919 8" x 4" Reducing Coupling Female Thread x Male Thread	729198040	\$474.98
	8" x 6"	219.1 x 168.3mm	72919 8" x 6" Reducing Coupling Female Thread x Male Thread	729198060	\$480.00
	10" x 8"	273.0 x 219.1mm	72919 10" x 8" Reducing Coupling Female Thread x Male Thread	729191080	\$719.00
	12" x 8"	323.9 x 219.1mm	72919 12" x 8" Reducing Coupling Female Thread x Male Thread	729191280	\$815.00
Note					
Orders for items in shaded areas <i>cannot</i> be cancelled or returned.					
Technical Data Sheet: G590					

G-MINE PVC Systems products have a 6 month warranty, contact GRINNELL Mechanical Products for additional information.
 See latest catalog or technical data sheets for specific approvals, listings, and design parameters.
 POA = Price on availability. Prices subject to change without notice.

Introduction
Couplings & Fittings
Mechanical Tees
Valves
Circuit Balancing Valves
Accessories
Copper Systems
Stainless Steel Systems
Plain End Systems
HDPE Systems
G-MINE PVC Systems
Gaskets & Spare Parts
Preparation Equipment
Miscellaneous
Indexes

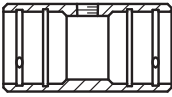

#72930 Outlet Coupling

	Pipe Size		Description	Part Number	List Price
	Nominal Size	Outside Diameter			
	2" x 3/4"	60.3 x 26.7mm	72930 2" x 3/4" Outlet Coupling	729302075	\$36.04
	2" x 1"	60.3 x 33.4mm	72930 2" x 1" Outlet Coupling	729302010	\$36.04
	3" x 3/4"	88.9 x 26.7mm	72930 3" x 3/4" Outlet Coupling	729303075	\$54.08
	3" x 1"	88.9 x 33.4mm	72930 3" x 1" Outlet Coupling	729303010	\$55.12
	3" x 1 1/2"	88.9 x 48.3mm	72930 3" x 1 1/2" Outlet Coupling	729303015	\$55.12
	4" x 3/4"	114.3 x 26.7mm	72930 4" x 3/4" Outlet Coupling	729304075	\$66.80
	4" x 1"	114.3 x 33.4mm	72930 4" x 1" Outlet Coupling	729304010	\$66.80
	4" x 1 1/2"	114.3 x 48.3mm	72930 4" x 1 1/2" Outlet Coupling	729304015	\$66.80
	6" x 3/4"	168.3 x 26.7mm	72930 6" x 3/4" Outlet Coupling	729306075	\$117.92
	6" x 1"	168.3 x 33.4mm	72930 6" x 1" Outlet Coupling	729306010	\$117.92
	6" x 1 1/2"	168.3 x 48.3mm	72930 6" x 1 1/2" Outlet Coupling	729306015	\$117.92
	8" x 1"	219.1 x 33.4mm	72930 8" x 1" Outlet Coupling	729308010	\$195.44
	8" x 1 1/2"	219.1 x 48.3mm	72930 8" x 1 1/2" Outlet Coupling	729308015	\$195.44
	10" x 1"	273.0 x 33.4mm	72930 10" x 1" Outlet Coupling	729301010	\$181.50
	10" x 1 1/2"	273.0 x 48.3mm	72930 10" x 1 1/2" Outlet Coupling	729301015	\$184.00
	12" x 1"	323.9 x 33.4mm	72930 12" x 1" Outlet Coupling	729301210	\$239.50
12" x 1 1/2"	323.9 x 48.3mm	72930 12" x 1 1/2" Outlet Coupling	729301215	\$241.50	

Note

Orders for items in shaded areas **cannot** be cancelled or returned.

Technical Data Sheet: G590

#72940 Male Thread x Female Thread Outlet Coupling

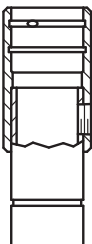
	Pipe Size		Description	Part Number	List Price
	Nominal Size	Outside Diameter			
	2" x 3/4"	60.3 x 26.7mm	72940 2" x 3/4" Outlet Coupling Male Thread x Female Thread	729402075	\$63.60
	2" x 1"	60.3 x 33.4mm	72940 2" x 1" Outlet Coupling Male Thread x Female Thread	729402010	\$63.60
	3" x 1 1/2"	88.9 x 48.3mm	72940 3" x 1 1/2" Outlet Coupling Male Thread x Female Thread	729403015	\$80.40
	4" x 1 1/2"	114.3 x 48.3mm	72940 4" x 1 1/2" Outlet Coupling Male Thread x Female Thread	729404015	\$92.00
	6" x 1"	168.3 x 33.4mm	72940 6" x 1" Outlet Coupling Male Thread x Female Thread	729406015	\$172.00
	6" x 1 1/2"	168.3 x 48.3mm	72940 6" x 1 1/2" Outlet Coupling Male Thread x Female Thread	729406020	\$172.00
	8" x 1"	219.1 x 33.4mm	72940 8" x 1" Outlet Coupling Male Thread x Female Thread	729408015	\$220.00
	8" x 1 1/2"	219.1 x 48.3mm	72940 8" x 1 1/2" Outlet Coupling Male Thread x Female Thread	729408020	\$220.00
	10" x 1"	273.0 x 33.4mm	72940 10" x 1" Outlet Coupling Male Thread x Female Thread	729401015	\$267.00
	10" x 1 1/2"	273.0 x 48.3mm	72940 10" x 1 1/2" Outlet Coupling Male Thread x Female Thread	729401020	\$269.50
	12" x 1"	323.9 x 33.4mm	72940 12" x 1" Outlet Coupling Male Thread x Female Thread	729401215	\$413.00
	12" x 1 1/2"	323.9 x 48.3mm	72940 12" x 1 1/2" Outlet Coupling Male Thread x Female Thread	729401220	\$413.00

Note

Orders for items in shaded areas **cannot** be cancelled or returned.

Technical Data Sheet: G590

#72906 Spline x Plain End Nipple

	Pipe Size		Description	Part Number	List Price
	Nominal Size	Outside Diameter			
	2"	60.3mm	72906 2" Spline x Plain End Nipple	7290620	\$10.60
	3"	88.9mm	72906 3" Spline x Plain End Nipple	7290630	\$14.80
	4"	114.3mm	72906 4" Spline x Plain End Nipple	7290640	\$20.80
	6"	168.3mm	72906 6" Spline x Plain End Nipple	7290660	\$36.96
	8"	219.1mm	72906 8" Spline x Plain End Nipple	7290680	\$67.60
	10"	273.0mm	72906 10" Spline x Plain End Nipple	7290610	\$98.00
	12"	323.9mm	72906 12" Spline x Plain End Nipple	7290612	\$136.50

Note

Orders for items in shaded areas **cannot** be cancelled or returned.

Technical Data Sheet: G590

#72907 Spline x Groove Nipple

	Pipe Size		Description	Part Number	List Price
	Nominal Size	Outside Diameter			
	2"	60.3mm	72907 2" Spline x Groove Nipple	7290720	\$20.00
	3"	88.9mm	72907 3" Spline x Groove Nipple	7290730	\$21.54
	4"	114.3mm	72907 4" Spline x Groove Nipple	7290740	\$33.32
	4"	114.3mm	72907 4" Spline x Groove Nipple H	7290740H	\$39.82
	6"	168.3mm	72907 6" Spline x Groove Nipple	7290760	\$50.00
	6"	168.3mm	72907 6" Spline x Groove Nipple H	7290760H	\$62.96
	8"	219.1mm	72907 8" Spline x Groove Nipple	7290780	\$96.00
	10"	273.0mm	72907 10" Spline x Groove Nipple	7290710	\$116.50
	12"	323.9mm	72907 12" Spline x Groove Nipple	7290712	\$155.00

Note

Orders for items in shaded areas **cannot** be cancelled or returned.

Technical Data Sheet: G590

#72908 Spline x Male Thread Nipple

	Pipe Size		Description	Part Number	List Price
	Nominal Size	Outside Diameter			
	2"	60.3mm	72908 2" Spline x Male Thread Nipple	7290820	\$21.28
	3"	88.9mm	72908 3" Spline x Male Thread Nipple	7290830	\$29.64
	4"	114.3mm	72908 4" Spline x Male Thread Nipple	7290840	\$39.68
	6"	168.3mm	72908 6" Spline x Male Thread Nipple	7290860	\$68.92
	8"	219.1mm	72908 8" Spline x Male Thread Nipple	7290880	\$138.00
	10"	273.0mm	72908 10" Spline x Male Thread Nipple	7290810	\$134.00
	12"	323.9mm	72908 12" Spline x Male Thread Nipple	7290812	\$172.50

Note

Orders for items in shaded areas **cannot** be cancelled or returned.

Technical Data Sheet: G590

G-MINE PVC Systems products have a 6 month warranty, contact GRINNELL Mechanical Products for additional information.
 See latest catalog or technical data sheets for specific approvals, listings, and design parameters.
 POA = Price on availability. Prices subject to change without notice.

Introduction
 Couplings & Fittings
 Mechanical Tees
 Valves
 Circuit Balancing Valves
 Accessories
 Copper Systems
 Stainless Steel Systems
 Plain End Systems
 HDPE Systems
 G-MINE PVC Systems
 Gaskets & Spare Parts
 Preparation Equipment
 Miscellaneous
 Indexes



#72909 Plain End x Male Thread Nipple

	Pipe Size		Description	Part Number	List Price
	Nominal Size	Outside Diameter			
	2"	60.3mm	72909 2" Plain End x Male Thread Nipple	7290920	\$16.32
	3"	88.9mm	72909 3" Plain End x Male Thread Nipple	7290930	\$26.20
	4"	114.3mm	72909 4" Plain End x Male Thread Nipple	7290940	\$40.28
	6"	168.3mm	72909 6" Plain End x Male Thread Nipple	7290960	\$73.06
	8"	219.1mm	72909 8" Plain End x Male Thread Nipple	7290980	\$105.34
	10"	273.0mm	72909 10" Plain End x Male Thread Nipple	7290910	\$118.50
	12"	323.9mm	72909 12" Plain End x Male Thread Nipple	7290912	\$149.50

Note

Orders for items in shaded areas *cannot* be cancelled or returned.

Technical Data Sheet: G590

#72911 Spline x Spline Nipple

	Pipe Size		Description	Part Number	List Price
	Nominal Size	Outside Diameter			
	4"	114.3mm	72911 4" Spline x Spline Nipple	7291140	\$26.08
	6"	168.3mm	72911 6" Spline x Spline Nipple	7291160	\$44.22
	8"	219.1mm	72911 8" Spline x Spline Nipple	7291180	\$75.04

Note

Orders for items in shaded areas *cannot* be cancelled or returned.

Technical Data Sheet: G590

#72910 90° Elbow

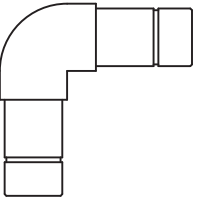
	Pipe Size		Description	Part Number	List Price
	Nominal Size	Outside Diameter			
	2"	60.3mm	72910 2" 90° Elbow	7291020	\$48.88
	3"	88.9mm	72910 3" 90° Elbow	7291030	\$85.56
	4"	114.3mm	72910 4" 90° Elbow	7291040	\$117.20
	6"	168.3mm	72910 6" 90° Elbow	7291060	\$265.10
	8"	219.1mm	72910 8" 90° Elbow	7291080	\$597.34
	10"	273.0mm	72910 10" 90 Deg Elbow	7291010	\$826.50
	12"	323.9mm	72910 12" 90 Deg Elbow	7291012	\$1,319.00

Note

Orders for items in shaded areas *cannot* be cancelled or returned.

Technical Data Sheet: G590

G-MINE PVC Systems products have a 6 month warranty, contact GRINNELL Mechanical Products for additional information.
See latest catalog or technical data sheets for specific approvals, listings, and design parameters.
POA = Price on availability. Prices subject to change without notice.

#72912 45° Elbow

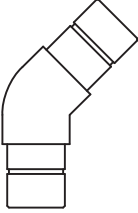
	Pipe Size		Description	Part Number	List Price
	Nominal Size	Outside Diameter			
	2"	60.3mm	72912 2" 45 Deg Elbow	7291220	\$67.48
	3"	88.9mm	72912 3" 45 Deg Elbow	7291230	\$129.78
	4"	114.3mm	72912 4" 45 Deg Elbow	7291240	\$206.56
	6"	168.3mm	72912 6" 45 Deg Elbow	7291260	\$294.80
	8"	219.1mm	72912 8" 45 Deg Elbow	7291280	\$574.52
	10"	273.0mm	72912 10" 45 Deg Elbow	7291210	\$627.00
	12"	323.9mm	72912 12" 45 Deg Elbow	7291212	\$886.50

Note

Orders for items in shaded areas *cannot* be cancelled or returned.

Technical Data Sheet: G590

#72913 90° Sweep

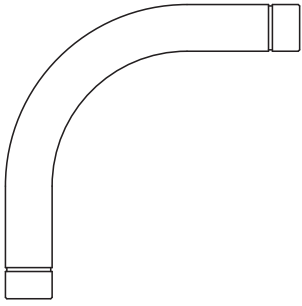
	Pipe Size		Description	Part Number	List Price
	Nominal Size	Outside Diameter			
	2"	60.3mm	72913 2" 90° Sweep	7291320	\$114.30
	3"	88.9mm	72913 3" 90° Sweep	7291330	\$192.00
	4"	114.3mm	72913 4" 90° Sweep	7291340	\$220.00
	4"	114.3mm	72913 4" 90° Sweep H	7291340H	\$240.00
	6"	168.3mm	72913 6" 90° Sweep	7291360	\$406.18
	6"	168.3mm	72913 6" 90° Sweep H	7291360H	\$569.88
	8"	219.1mm	72913 8" 90° Sweep	7291380	\$680.00
	10"	273.0mm	72913 10" 90 Deg Sweep	7291310	\$1,116.00
	12"	323.9mm	72913 12" 90 Deg Sweep	7291312	\$1,524.50

Note

Orders for items in shaded areas *cannot* be cancelled or returned.

Technical Data Sheet: G590

#72914 45° Sweep

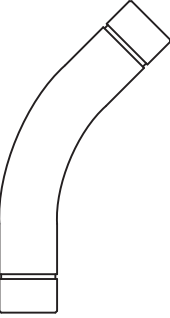
	Pipe Size		Description	Part Number	List Price
	Nominal Size	Outside Diameter			
	2"	60.3mm	72914 2" 45° Sweep	7291420	\$114.34
	3"	88.9mm	72914 3" 45° Sweep	7291430	\$180.00
	4"	114.3mm	72914 4" 45° Sweep	7291440	\$200.00
	4"	114.3mm	72914 4" 45° Sweep H	7291440H	\$220.00
	6"	168.3mm	72914 6" 45° Sweep	7291460	\$260.00
	6"	168.3mm	72914 6" 45° Sweep H	7291460H	\$364.82
	8"	219.1mm	72914 8" 45° Sweep	7291480	\$472.00
	10"	273.0mm	72914 10" 45 Deg Sweep	7291410	\$809.00
	12"	323.9mm	72914 12" 45 Deg Sweep	7291412	\$1,155.00

Note

Orders for items in shaded areas *cannot* be cancelled or returned.

Technical Data Sheet: G590

G-MINE PVC Systems products have a 6 month warranty, contact GRINNELL Mechanical Products for additional information.
 See latest catalog or technical data sheets for specific approvals, listings, and design parameters.
 POA = Price on availability. Prices subject to change without notice.

Introduction
 Couplings & Fittings
 Mechanical Tees
 Valves
 Circuit Balancing Valves
 Accessories
 Copper Systems
 Stainless Steel Systems
 Plain End Systems
 HDPE Systems
 G-MINE PVC Systems
 Gaskets & Spare Parts
 Preparation Equipment
 Miscellaneous
 Indexes



#72915 Cap

	Pipe Size		Description	Part Number	List Price
	Nominal Size	Outside Diameter			
	2"	60.3mm	72915 2" Cap	7291520	\$42.88
	3"	88.9mm	72915 3" Cap	7291530	\$64.00
	4"	114.3mm	72915 4" Cap	7291540	\$189.32
	6"	168.3mm	72915 6" Cap	7291560	\$258.60
	8"	219.1mm	72915 8" Cap	7291580	\$304.26
	10"	273.0mm	72915 10" End Cap	7291510	\$449.00
	12"	323.9mm	72915 12" End Cap	7291512	\$653.00

Note

Orders for items in shaded areas **cannot** be cancelled or returned.

Technical Data Sheet: G590

#72916 Flange Adapter 150psi

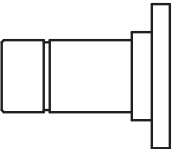
	Pipe Size		Description	Part Number	List Price
	Nominal Size	Outside Diameter			
	2"	60.3mm	72916 2" Flange Adapter 150psi	7291620	\$54.64
	3"	88.9mm	72916 3" Flange Adapter 150psi	7291630	\$88.60
	4"	114.3mm	72916 4" Flange Adapter 150psi	7291640	\$107.46
	6"	168.3mm	72916 6" Flange Adapter 150psi	7291660	\$184.06
	8"	219.1mm	72916 8" Flange Adapter 150psi	7291680	\$278.62
	10"	273.0mm	72916 10" Flange Adapter 150psi	7291610	\$391.50
	12"	323.9mm	72916 12" Flange Adapter 150psi	7291612	\$523.50

Note

Orders for items in shaded areas **cannot** be cancelled or returned.

Technical Data Sheet: G590

#72917 Tee

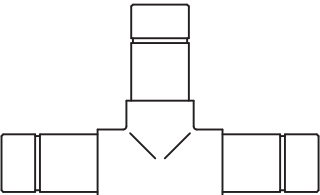
	Pipe Size		Description	Part Number	List Price
	Nominal Size	Outside Diameter			
	2"	60.3mm	72917 2" Tee	7291720	\$98.96
	3"	88.9mm	72917 3" Tee	7291730	\$136.58
	4"	114.3mm	72917 4" Tee	7291740	\$167.80
	6"	168.3mm	72917 6" Tee	7291760	\$422.92
	8"	219.1mm	72917 8" Tee	7291780	\$848.12
	10"	273.0mm	72917 10" Tee	7291710	\$1,133.50
	12"	323.9mm	72917 12" Tee	7291712	\$1,601.00

Note

Orders for items in shaded areas **cannot** be cancelled or returned.

Technical Data Sheet: G590

G-MINE PVC Systems products have a 6 month warranty, contact GRINNELL Mechanical Products for additional information.
See latest catalog or technical data sheets for specific approvals, listings, and design parameters.
POA = Price on availability. Prices subject to change without notice.

#72918 Reducing Tee

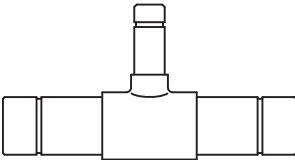
	Pipe Size		Description	Part Number	List Price
	Nominal Size	Outside Diameter			
	3" x 2"	88.9 x 60.3mm	72918 3" x 2" Reducing Tee	729183020	\$124.14
	4" x 2"	114.3 x 60.3mm	72918 4" x 2" Reducing Tee	729184020	\$244.18
	4" x 3"	114.3 x 88.9mm	72918 4" x 3" Reducing Tee	729184030	\$249.42
	6" x 2"	168.3 x 60.3mm	72918 6" x 2" Reducing Tee	729186020	\$616.94
	6" x 3"	168.3 x 88.9mm	72918 6" x 3" Reducing Tee	729186030	\$622.10
	6" x 4"	168.3 x 114.3mm	72918 6" x 4" Reducing Tee	729186040	\$632.32
	8" x 6"	219.1 x 168.3mm	72918 8" x 6" Reducing Tee	729188060	\$859.40
Note					
Orders for items in shaded areas <i>cannot</i> be cancelled or returned.					
Technical Data Sheet: G590					

#B8200L G-MINE Butterfly Valve – EPDM

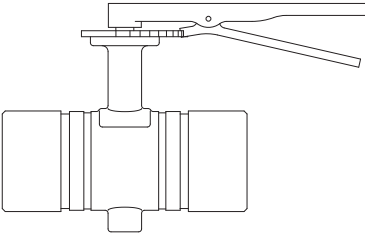
	Nominal Size	Part Number	List Price
	2"	B820020	\$266.50
	3"	B820030	\$349.00
	4"	B820040	\$449.00
	6"	B820060	\$749.50
Note			
Orders for items in shaded areas <i>cannot</i> be cancelled or returned.			
Technical Data Sheet: G592			

Introduction
 Couplings & Fittings
 Mechanical Tees
 Valves
 Circuit Balancing Valves
 Accessories
 Copper Systems
 Stainless Steel Systems
 Plain End Systems
 HDPE Systems
G-MINE PVC Systems
 Gaskets & Spare Parts
 Preparation Equipment
 Miscellaneous
 Indexes



#72999 Spline

	Nominal Size	Description	Part Number	List Price
	2"	72999 2" Spline	7299920	\$2.20
	3"	72999 3" Spline	7299930	\$3.62
	4"	72999 4" Spline	7299940	\$4.12
	4"	72999 4" Spline H	7299940H	\$6.04
	6"	72999 6" Spline	7299960	\$6.76
	6"	72999 6" Spline H	7299960H	\$7.48
	8"	72999 8" Spline	7299980	\$15.12
	10"	72999 10" Spline	7299910	\$28.00
	12"	72999 12" Spline	7299912	\$28.00

Note

Orders for items in shaded areas *cannot* be cancelled or returned.

Technical Data Sheet: G590

#ITGM Insertion Tool

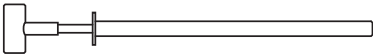
	Pipe Size	Description	Part Number	List Price
	3" - 6"	ITGM 3" - 6" Insertion Tool	ITGM36	\$100.00
	8"	ITGM 8" Insertion Tool	ITGM8	\$120.00

Note

Orders for items in shaded areas *cannot* be cancelled or returned.

Technical Data Sheet: G590

#72899 Replacement Gaskets

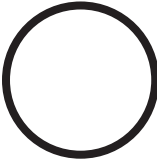
	Pipe Size		Description	Part Number	List Price
	Nominal Size	Outside Diameter			
	2"	60.3mm	72899 2" Replacement Gasket	7289920	\$1.96
	3"	88.9mm	72899 3" Replacement Gasket	7289930	\$2.36
	4"	114.3mm	72899 4" Replacement Gasket	7289940	\$2.64
	6"	168.3mm	72899 6" Replacement Gasket	7289960	\$6.68
	8"	219.1mm	72899 8" Replacement Gasket	7289980	\$6.76
	10"	273.0mm	72899 10" Replacement Gasket	7289910	\$7.90
	12"	323.9mm	72899 12" Replacement Gasket	7289912	\$11.55

Note

Orders for items in shaded areas *cannot* be cancelled or returned.

Technical Data Sheet: G590

G-MINE PVC Systems products have a 6 month warranty, contact GRINNELL Mechanical Products for additional information.
See latest catalog or technical data sheets for specific approvals, listings, and design parameters.
POA = Price on availability. Prices subject to change without notice.

**Replacement Gaskets – EPDM “E” Gaskets,
 For #577, #772, #770, #705, #707**

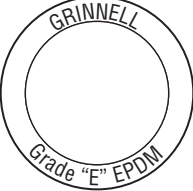
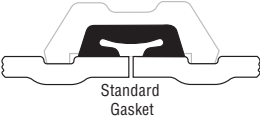
	<i>Pipe Size</i>		<i>Part No. “E” EPDM</i>	<i>List Price</i>
	<i>Nominal Size</i>	<i>Outside Diameter</i>		
  <p>Standard Gasket</p>	1"	33.4mm	10EPDM	\$15.47
	1¼"	42.4mm	12EPDM	\$15.93
	1½"	48.3mm	15EPDM	\$17.31
	2"	60.3mm	20EPDM	\$17.31
	2½"	73.0mm	25EPDM	\$20.98
	76.1mm	76.1mm	26EPDM	\$20.98
	3"	88.9mm	30EPDM	\$23.05
	4"	114.3mm	42EPDM	\$29.41
	139.7mm	139.7mm	52EPDM	\$38.16
	5"	141.3mm	53EPDM	\$38.16
	165.1mm	165.1mm	62EPDM	\$41.87
	6"	168.3mm	63EPDM	\$41.87
	8"	219.1mm	80EPDM	\$57.51
	10"	273.0mm	11EPDM	\$73.65
	12"	323.9mm	13EPDM	\$85.67
	14"	355.6mm	14EPDM	\$118.24
	16"	406.4mm	16EPDM	\$164.28
	18"	457.2mm	18EPDM	\$198.63
	20"	508.0mm	21EPDM	\$305.54
	24"	609.6mm	24EPDM	\$424.80
Notes				
For price and availability for Grade “T” Nitrile gaskets, contact GRINNELL Mechanical Products.				
Orders for items in shaded areas <i>cannot</i> be cancelled or returned.				
Technical Data Sheet: G610				

Introduction
 Couplings & Fittings
 Mechanical Tees
 Valves
 Circuit Balancing Valves
 Accessories
 Copper Systems
 Stainless Steel Systems
 Plain End Systems
 HDPE Systems
 G-MINE PVC Systems
 Gaskets & Spare Parts
 Preparation Equipment
 Miscellaneous
 Indexes



Replacement Tri-Seal Gaskets – EPDM “E” Gaskets, For #577, #772, #770, #705, #707

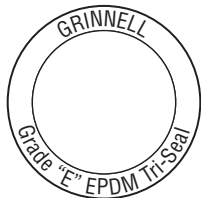

Tri-Seal Gasket

	Pipe Size		Part No. “E” EPDM	List Price
	Nominal Size	Outside Diameter		
	1"	33.4mm	10EPDM-TRI	\$30.27
	1 1/4"	42.4mm	12EPDM-TRI	\$31.92
	1 1/2"	48.3mm	15EPDM-TRI	\$32.25
	2"	60.3mm	20EPDM-TRI	\$32.82
	2 1/2"	73.0mm	25EPDM-TRI	\$40.62
	76.1mm	76.1mm	26EPDM-TRI	\$40.62
	3"	88.9mm	30EPDM-TRI	\$40.62
	4"	114.3mm	42EPDM-TRI	\$55.33
	139.7mm	139.7mm	52EPDM-TRI	\$100.00
	5"	141.3mm	53EPDM-TRI	\$100.00
	165.1mm	165.1mm	62EPDM-TRI	\$101.77
	6"	168.3mm	63EPDM-TRI	\$101.77
	8"	219.1mm	80EPDM-TRI	\$105.99
	10"	273.0mm	11EPDM-TRI	\$136.69
	12"	323.9mm	13EPDM-TRI	\$163.69
	14"	355.6mm	14EPDME3	\$200.14
	16"	406.4mm	16EPDME3	\$218.00
	18"	457.2mm	18EPDME3	\$277.09
	20"	508.0mm	21EPDME3	\$327.71
	24"	609.6mm	24EPDME3	\$451.66

Notes

For price and availability for Grade “T” Nitrile gaskets, contact GRINNELL Mechanical Products.

Orders for items in shaded areas **cannot** be cancelled or returned.

Technical Data Sheet: G610

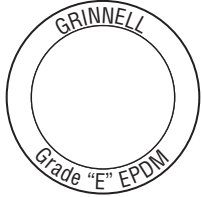
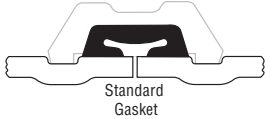

**Replacement WRAS Gaskets – EPDM “E” Gaskets,
 For #577, Recommended for Potable Water**

  Standard Gasket	Pipe Size		Part No. “E” EPDM	List Price
	Nominal Size	Outside Diameter		
	1"	33.4mm	10EPDM-PW	POA
	1 1/4"	42.4mm	12EPDM-PW	\$6.32
	1 1/2"	48.3mm	15EPDM-PW	\$6.88
	2"	60.3mm	20EPDM-PW	\$8.08
	2 1/2"	73.0mm	25EPDM-PW	\$9.58
	76.1mm	76.1mm	26EPDM-PW	\$10.02
	3"	88.9mm	30EPDM-PW	\$10.43
	4"	114.3mm	42EPDM-PW	\$15.68
	139.7mm	139.7mm	52EPDM-PW	\$21.92
	165.1mm	165.1mm	62EPDM-PW	\$26.45
	6"	168.3mm	63EPDM-PW	\$25.07
	8"	219.1mm	80EPDM-PW	\$43.45

Note

Orders for items in shaded areas *cannot* be cancelled or returned.

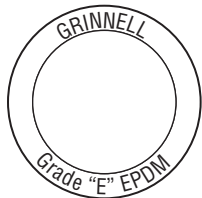
**Replacement Gaskets – EPDM “E” Gaskets
 For # 716 Reducing Coupling**

  Standard Gasket	Pipe Size		Part No. “E” EPDM	List Price
	Nominal Size	Outside Diameter		
	2" x 1 1/2"	60.3 x 48.3mm	EPDM2015	\$15.70
	2 1/2" x 2"	73.0 x 60.3mm	EPDM2520	\$20.71
	76.1mm x 2"	76.1 x 60.3mm	EPDM2620	\$20.71
	3" x 2"	88.9 x 60.3mm	EPDM3020	\$24.56
	3" x 2 1/2"	88.9 x 73.0mm	EPDM3025	\$24.56
	3" x 76.1mm	88.9 x 76.1mm	EPDM3026	\$24.56
	4" x 2"	114.3 x 60.3mm	EPDM4220	\$28.93
	4" x 2 1/2"	114.3 x 73.0mm	EPDM4225	\$29.15
	4" x 76.1mm	114.3 x 76.1mm	EPDM4226	\$29.22
	4" x 3"	114.3 x 88.9mm	EPDM4230	\$30.23
	139.7mm x 4"	139.7 x 114.3mm	EPDM5242	\$36.49
	5" x 4"	141.3 x 114.3mm	EPDM5342	\$36.49
	165.1mm x 4"	165.1 x 114.3mm	EPDM6242	\$40.96
	6" x 4"	168.3 x 114.3mm	EPDM6342	\$40.96
	6" x 5"	168.3 x 141.3mm	EPDM6553	\$44.93
	8" x 6"	219.1 x 168.3mm	EPDM8063	\$49.76

Notes

For price and availability for Grade “T” Nitrile gaskets, contact GRINNELL Mechanical Products.

Orders for items in shaded areas *cannot* be cancelled or returned.

Technical Data Sheet: G610

**Replacement Gaskets – EPDM “E” Gaskets
 For #780 Snap Coupling**

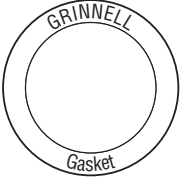
	Pipe Size		Grade “E” EPDM	List Price
	Nominal Size	Outside Diameter		
	1½"	48.3mm	78015EPDME	\$17.31
	2"	60.3mm	78020EPDME	\$17.31
	2½"	73.0mm	78025EPDME	\$20.98
	3"	88.9mm	78030EPDME	\$23.05
	4"	114.3mm	78040EPDME	\$29.41
	5"	141.3mm	78050EPDME	\$38.16
	6"	168.3mm	78060EPDME	\$41.87
	8"	219.1mm	78080EPDME	\$57.51
Notes				
For price and availability for Grade “T” Nitrile gaskets, contact GRINNELL Mechanical Products.				
Orders for items in shaded areas <i>cannot</i> be cancelled or returned.				
Technical Data Sheet: G610				

**#71 Flange Adapter Replacement
 “E” EPDM Gasket**

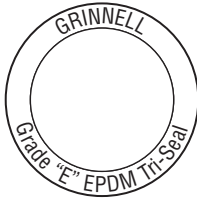
	Pipe Size		Part No. “E” EPDM	List Price
	Nominal Size	Outside Diameter		
	2"	60.3mm	7120EPDME	\$13.25
	2½"	73.0mm	7125EPDME	\$15.97
	76.1mm	76.1mm	7126EPDME	\$44.37
	3"	88.9mm	7130EPDME	\$17.56
	4"	114.3mm	7140EPDME	\$23.16
	139.7mm	139.7mm	7152EPDME	\$35.73
	5"	141.3mm	7150EPDME	\$28.93
	165.1mm	165.1mm	7162EPDME	\$31.02
	6"	168.3mm	7160EPDME	\$32.72
	8"	219.1mm	7180EPDME	\$44.93
	10"	273.0mm	7110EPDME	\$57.99
	12"	323.9mm	7112EPDME	\$67.42
	14"	355.6mm	7114EPDME	\$89.42
	16"	406.4mm	7116EPDME	\$99.85
	18"	457.2mm	7118EPDME	\$181.73
	20"	508.0mm	7121EPDME	\$219.74
	24"	609.6mm	7124EPDME	\$246.53
Notes				
For price and availability for Grade “T” Nitrile gaskets, contact GRINNELL Mechanical Products.				
Orders for items in shaded areas <i>cannot</i> be cancelled or returned.				
Technical Data Sheet: G610				

**#71 Flange Washer Adapter
 Carbon Steel**

	<i>Pipe Size</i>		<i>Part Number</i>	<i>List Price</i>
	<i>Nominal Size</i>	<i>Outside Diameter</i>		
	2"	60.3mm	INS060M	\$16.52
	2½"	73.0mm	INS073M	\$21.05
	76.1mm	76.1mm	INSDI076M	\$21.05
	3"	88.9mm	INS089M	\$23.83
	4"	114.3mm	INS114M	\$28.62
	139.7mm	139.7mm	INSDIN139M	\$34.11
	5"	141.3mm	INS141M	\$47.50
	165.1mm	165.1mm	INSDIN165M	\$40.79
	6"	168.3mm	INS168M	\$40.79
	8"	219.1mm	INS219M	\$54.90
	10"	273.0mm	INS273M	\$76.05
	12"	323.9mm	INS324M	\$94.40
	14"	355.6mm	7114FWC	\$131.50
	16"	406.4mm	7116FWC	\$146.00
	18"	457.2mm	7118FWC	\$213.00
	20"	508.0mm	7121FWC	\$230.50
24"	609.6mm	7124FWC	\$256.00	

Note

Orders for items in shaded areas *cannot* be cancelled or returned.

Technical Data Sheet: G610

Introduction
 Couplings & Fittings
 Mechanical Tees
 Valves
 Circuit Balancing Valves
 Accessories
 Copper Systems
 Stainless Steel Systems
 Plain End Systems
 HDPE Systems
 G-MINE PVC Systems
Gaskets & Spare Parts
 Preparation Equipment
 Miscellaneous
 Indexes

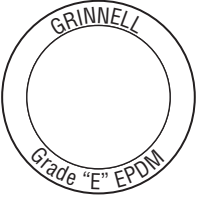

#730 Replacement "E" EPDM Gasket

	Pipe Size		"E" EPDM Gasket	List Price
	Nominal Size	Outside Diameter		
	2" x 1/2"	60.3 x 21.3mm	1EPDM730	\$9.47
	2" x 3/4"	60.3 x 26.7mm	1EPDM730	\$9.47
	2" x 1"	60.3 x 33.4mm	1EPDM730	\$9.47
	2" x 1 1/4"	60.3 x 42.4mm	2EPDM730	\$9.47
	2" x 1 1/2"	60.3 x 48.3mm	2EPDM730	\$9.47
	2 1/2" x 1/2"	73.0 x 21.3mm	1EPDM730	\$9.47
	2 1/2" x 3/4"	73.0 x 26.7mm	1EPDM730	\$9.47
	2 1/2" x 1"	73.0 x 33.4mm	1EPDM730	\$9.47
	2 1/2" x 1 1/4"	73.0 x 42.4mm	3EPDM730	\$9.47
	2 1/2" x 1 1/2"	73.0 x 48.3mm	3EPDM730	\$9.47
	2 1/2" x 2"	73.0 x 60.3mm	3EPDM730	\$9.47
	76.1 x 21.3mm	76.1 x 21.3mm	1EPDM730	\$9.47
	76.1 x 26.7mm	76.1 x 26.7mm	1EPDM730	\$9.47
	76.1 x 33.4mm	76.1 x 33.4mm	1EPDM730	\$9.47
	76.1 x 42.4mm	76.1 x 42.4mm	3EPDM730	\$9.47
	76.1 x 48.3mm	76.1 x 48.3mm	3EPDM730	\$9.47
	76.1 x 60.3mm	76.1 x 60.3mm	3EPDM730	\$9.47
	3" x 1/2"	88.9 x 21.3mm	1EPDM730	\$9.47
	3" x 3/4"	88.9 x 26.7mm	1EPDM730	\$9.47
	3" x 1"	88.9 x 33.4mm	1EPDM730	\$9.47
	3" x 1 1/4"	88.9 x 42.4mm	2EPDM730	\$9.47
	3" x 1 1/2"	88.9 x 48.3mm	3EPDM730	\$9.47
	3" x 2"	88.9 x 60.3mm	4EPDM730	\$9.47
	4" x 1/2"	114.3 x 21.3mm	1EPDM730	\$9.47
	4" x 3/4"	114.3 x 26.7mm	1EPDM730	\$9.47
	4" x 1"	114.3 x 33.4mm	1EPDM730	\$9.47
	4" x 1 1/4"	114.3 x 42.4mm	2EPDM730	\$9.47
	4" x 1 1/2"	114.3 x 48.3mm	3EPDM730	\$9.47
	4" x 2"	114.3 x 60.3mm	4EPDM730	\$9.47
	4" x 2 1/2"	114.3 x 73.0mm	5EPDM730	\$15.62
4" x 76.1mm	114.3 x 76.1mm	5EPDM730	\$15.62	
4" x 3"	114.3 x 88.9mm	7EPDM730	\$15.62	
5" x 1 1/2"	141.3 x 48.3mm	3EPDM730	\$15.62	
5" x 2"	141.3 x 60.3mm	4EPDM730	\$15.62	
5" x 2 1/2"	141.3 x 73.0mm	5EPDM730	\$15.62	
5" x 76.1mm	141.3 x 76.1mm	5EPDM730	\$15.62	
5" x 3"	141.3 x 88.9mm	7EPDM730	\$15.62	
165.1 x 60.3mm	165.1 x 60.3mm	5EPDM730	\$15.62	
165.1 x 76.1mm	165.1 x 76.1mm	7EPDM730	\$15.62	
165.1 x 88.9mm	165.1 x 88.9mm	9EPDM730	\$15.62	

See latest catalog or technical data sheets for specific approvals, listings, and design parameters.
POA = Price on availability. Prices subject to change without notice.

#730 Replacement “E” EPDM Gasket

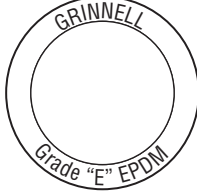
	6" x 1 1/4"	168.3 x 42.4mm	3EPDM730	\$9.47
	6" x 1 1/2"	168.3 x 48.3mm	3EPDM730	\$9.47
	6" x 2"	168.3 x 60.3mm	4EPDM730	\$9.47
	6" x 2 1/2"	168.3 x 73.0mm	6EPDM730	\$15.62
	6" x 76.1mm	168.3 x 76.1mm	7EPDM730	\$15.62
	6" x 3"	168.3 x 88.9mm	8EPDM730	\$15.62
	6" x 4"	168.3 x 114.3mm	9EPDM730	\$19.75
	8" x 2"	219.1 x 60.3mm	5EPDM730	\$17.41
	8" x 2 1/2"	219.1 x 73.0mm	6EPDM730	\$17.41
	8" x 76.1mm	219.1 x 76.1mm	7EPDM730	\$17.41
	8" x 3"	219.1 x 88.9mm	8EPDM730	\$15.62
	8" x 4"	219.1 x 114.3mm	9EPDM730	\$42.45

Notes

For price and availability for Grade “T” Nitrile gaskets, contact GRINNELL Mechanical Products.

Orders for items in shaded areas **cannot** be cancelled or returned.

Technical Data Sheet: G610

**Replacement Gaskets – Grade “EN” Tri-Seal
 (for #672 Coupling)**

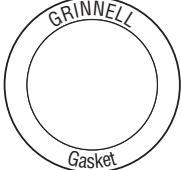
	Pipe Size		Part Number	List Price
	Nominal Size	Outside Diameter		
	2"	60.3mm	20EN3	\$35.00
	2 1/2"	73.0mm	25EN3	\$38.00
	3"	88.9mm	30EN3	\$40.50
	4"	114.3mm	40EN3	\$59.00
	5"	141.3mm	50EN3	\$98.50
	6"	168.3mm	60EN3	\$129.00
	8"	219.1mm	80EN3	\$201.50

Note

Orders for items in shaded areas **cannot** be cancelled or returned.

Technical Data Sheet: G610

**Replacement Gaskets – Grade “EHT” EPDM Center-Stop Push-On Style Gasket
 (for #640 Coupling)**

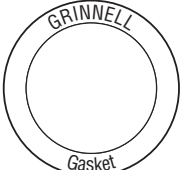
	Pipe Size		Part Number	List Price
	Nominal Size	Outside Diameter		
	2"	60.3mm	20EHTC	\$35.00
	2 1/2"	73.0mm	25EHTC	\$38.00
	3"	88.9mm	30EHTC	\$40.00
	4"	114.3mm	40EHTC	\$59.00
	5"	141.3mm	50EHTC	\$98.50
	6"	168.3mm	60EHTC	\$129.00
	8"	219.1mm	80EHTC	\$201.00

Note

Orders for items in shaded areas **cannot** be cancelled or returned.

Technical Data Sheet: G610

Introduction
 Couplings & Fittings
 Mechanical Tees
 Valves
 Circuit Balancing Valves
 Accessories
 Copper Systems
 Stainless Steel Systems
 Plain End Systems
 HDPE Systems
 G-MINE PVC Systems
 Gaskets & Spare Parts
 Preparation Equipment
 Miscellaneous
 Indexes



Replacement Gaskets – Grade “EN” EPDM (for #61 Flange Adapter)

	Pipe Size		Part Number	List Price
	Nominal Size	Outside Diameter		
	2"	60.3mm	6120NSF	\$28.00
	2½"	73.0mm	6125NSF	\$31.50
	3"	88.9mm	6130NSF	\$34.00
	4"	114.3mm	6140NSF	\$43.00
	5"	141.3mm	6150NSF	\$52.50
	6"	168.3mm	6160NSF	\$60.50

Note

Orders for items in shaded areas *cannot* be cancelled or returned.

Technical Data Sheet: G610

Phenolic Washer (for #61 Flange Adapter)

	Pipe Size		Part Number	List Price
	Nominal Size	Outside Diameter		
	2"	60.3mm	61PW20	\$44.50
	2½"	73.0mm	61PW25	\$48.50
	3"	88.9mm	61PW30	\$52.00
	4"	114.3mm	61PW40	\$82.50
	5"	141.3mm	61PW50	\$90.00
	6"	168.3mm	61PW60	\$102.00

Note

Orders for items in shaded areas *cannot* be cancelled or returned.

Technical Data Sheet: G610

**Replacement Gaskets – EPDM “E” Gaskets
 For #909 Plain End Coupling**

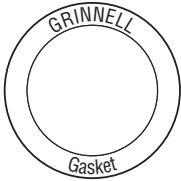
	<i>Nominal Size</i>	<i>Outside Diameter</i>	<i>Grade “E” EPDM Part No.</i>	<i>List Price</i>
	2"	60.3mm	20EPDME909	\$35.49
	2½"	73.0mm	25EPDME909	\$37.58
	3"	88.9mm	30EPDME909	\$41.65
	4"	114.3mm	42EPDME909	\$62.74
	6"	168.3mm	63EPDME909	\$90.43
	8"	219.1mm	80EPDME909	\$120.09
	10"	273.0mm	11EPDME909	\$120.09
	12"	323.9mm	13EPDME909	\$183.00
	14"	355.6mm	14EPDME909	\$278.50
16"	406.4mm	16EPDME909	\$330.00	
18"	457.2mm	18EPDME909	\$528.00	

Notes

For price and availability for Grade “T” Nitrile gaskets, contact GRINNELL Mechanical Products.

Orders for items in shaded areas *cannot* be cancelled or returned.

Technical Data Sheet: G610

HDPE – #9094 Replacement Gaskets “E”

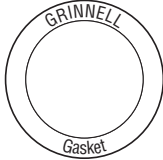
	<i>Nominal Size</i>	<i>Outside Diameter</i>	<i>Model Number</i>	<i>List</i>
	4"	114.3mm	909440EPDME	\$131.00
	6"	168.3mm	909460EPDME	\$133.50
	8"	219.1mm	909480EPDME	\$136.50

Note

Orders for items in shaded areas *cannot* be cancelled or returned.

Technical Data Sheet: G610

HDPE – #9095 Replacement Gaskets “E”

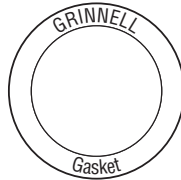
	<i>Nominal Size</i>	<i>Outside Diameter</i>	<i>Model Number</i>	<i>List</i>
	2"	60.3mm	909520EPDME	\$37.00
	3"	88.9mm	909530EPDME	\$43.00
	4"	114.3mm	909540EPDME	\$62.50
	5"	141.3mm	909550EPDME	\$74.00
	6"	168.3mm	909560EPDME	\$90.00
	8"	219.1mm	909580EPDME	\$117.50
	10"	273.0mm	909510EPDME	\$150.50
	12"	323.9mm	909512EPDME	\$183.00

Note

Orders for items in shaded areas *cannot* be cancelled or returned.

Technical Data Sheet: G610

Introduction
 Couplings & Fittings
 Mechanical Tees
 Valves
 Circuit Balancing Valves
 Accessories
 Copper Systems
 Stainless Steel Systems
 Plain End Systems
 HDPE Systems
 G-MINE PVC Systems
 Gaskets & Spare Parts
 Preparation Equipment
 Miscellaneous
 Indexes

HDPE – #9097 Replacement Gaskets “E”

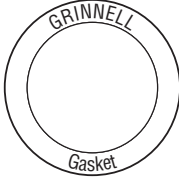
	Nominal Size	Outside Diameter	Model Number	List Price
	2"	60.3mm	909720EPDME	\$29.50
	3"	88.9mm	909730EPDME	\$37.50
	4"	114.3mm	909740EPDME	\$47.00
	5"	141.3mm	909750EPDME	\$60.50
	6"	168.3mm	909760EPDME	\$65.50
	8"	219.1mm	909780EPDME	\$89.50
	10"	273.0mm	909710EPDME	\$112.50
	12"	323.9mm	909712EPDME	\$131.00

Note

 Orders for items in shaded areas *cannot* be cancelled or returned.

Technical Data Sheet: G610
Coupling Nut and Bolt Kit

	Nominal Size	Qty/Kit	Part No.	List Price
	3/8" x 2 1/4"	2	NB37225	\$13.00
	1/2" x 3"	2	NB50300	\$13.50
	5/8" x 3 1/4"	2	NB62325	\$7.33
	5/8" x 4 3/4"	2	NB62475	\$7.68
	3/4" x 4 3/4"	2	NB75475	\$25.50
	7/8" x 6 1/2"	2	NB87650	\$17.31
	1" x 5 1/2"	3	NB10550	\$11.32
	1" x 6 1/2"	2	NB10650	\$18.77
1 1/8" x 5 3/4"	4	NB12575	\$59.00	

Notes

 Orders for items in shaded areas *cannot* be cancelled or returned.

All standard couplings can be provided with stainless steel nuts and bolts upon request.

#71 Nut, Bolt, and Gasket Kit

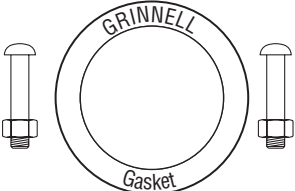
	Nominal Size	Outside Diameter	Part Number	List Price
	2"	60.3mm	50240	POA
	2 1/2"	73.0mm	50241	POA
	3"	88.9mm	50242	POA
	4"	114.3mm	50243	POA
	5"	141.3mm	50248	POA
	6"	168.3mm	50244	POA
	8"	219.1mm	50245	POA
	10"	273.0mm	50246	POA
12"	323.9mm	50247	POA	

Note

 Orders for items in shaded areas *cannot* be cancelled or returned.

Technical Data Sheet: G610

Pipe Tape Chrome Plated with GRINNELL Logo

	<i>Part Number</i>	<i>List Price</i>
	PT1000	\$41.76

GRINNELL Gasket Lubricant

	<i>Nominal Size</i>	<i>Part Number</i>	<i>List Price</i>
	1 Quart	70008E	\$69.70

Note

Orders for items in shaded areas *cannot* be cancelled or returned.

GRINNELL Silicone Gasket Lubricant
Recommended for use with Tri-Seal Gasket
Dow Corning* #DC No. 7

	<i>Nominal Size</i>	<i>Part Number</i>	<i>List Price</i>
	5.3 oz. Tube	32037	POA
	8 lb. Can	32038	POA

Note

Orders for items in shaded areas *cannot* be cancelled or returned.

Introduction
 Couplings & Fittings
 Mechanical Tees
 Valves
 Circuit Balancing Valves
 Accessories
 Copper Systems
 Stainless Steel Systems
 Plain End Systems
 HDPE Systems
 G-MINE PVC Systems
Gaskets & Spare Parts
 Preparation Equipment
 Miscellaneous
 Indexes



Roll Grooving Machine Selection Chart

Machine Type	Pace Model	Size Range				Drive	Rolls Supplied			Part No.	List Price **
		Sch. 40	Sch. 10	Std. Wall	Copper		Size	Steel	Copper		
Portable with Electric Motor	1112	1" - 12"	-	-	2" - 8"	1 1/2 HP, 110V	1" - 12"	■		41048	POA
	1010	1 1/2" - 6"	1 1/2" - 12"	-	-	1/2 HP, 110V	1 1/2" - 12"	■		41030	POA
	1023	1 1/4" - 12"	-	12" - 24"	2" - 8"	1 1/2 HP, 110V	1 1/4" - 12"	■		41029	POA
							2" - 12"	■		41250	POA
							1 1/4" - 24"	■		41251	POA
							2" - 24"	■		41252	POA
	1021	1 1/4" - 12"	-	12" - 24"	2" - 8"	2 HP, 220V	1 1/4" - 12"	■		41253	POA
							2" - 12"	■		41254	POA
							1 1/4" - 24"	■		41255	POA
							2" - 24"	■		41256	POA
Portable for Ridgid® 300	1012	1" - 12"	-	-	2" - 8"	Ridgid® 300	1" - 12"	■		41041	POA
	1022	1 1/4" - 12"	-	12" - 16"	2" - 8"	Ridgid® 300	1 1/4" - 16"	■		41027	POA
	1041	1" - 6"	1" - 12"	-	2" - 8"	Ridgid® 300	1" - 12"	■		41018	POA
Mini-Mites	1039-66	1 1/4" - 6"	-	-	2" - 8"	Ridgid® 300, Hand Crank	2" - 8" CTS		■	41047	POA
	1039	1 1/4" - 6"	-	-	2" - 8"	Ridgid® 300, Hand Crank	1 1/4" - 6" IPS	■		41017	POA
	1034	1 1/4" - 6"	-	-	-	Ridgid® 300	1 1/4" - 6" IPS	■		41015	POA
	1066	-	-	-	2" - 8"	Ridgid® 300	2" - 8" CTS		■	41014	POA
Automated	2021	1 1/4" - 12"	-	12" - 24"	2" - 8"	3 HP, 220V	1 1/4" - 12"	■		41257	POA
							2" - 12"	■		41258	POA
							1 1/4" - 24"	■		41032	POA
							2" - 24"	■		41259	POA
	2050	4" - 12"	4" - 30"	12" - 30"		5 HP, 220V	4" - 6"	■		41033	POA
2112	1" - 12"	-	-	2" - 8"	1/2 HP, 110V	1 1/2" - 12"	■		41210	POA	
Portable Cut Groover	1000	2" - 8"	-	-	-	1 HP, 115V	2" - 8"			41260	POA
		2" - 12"	-	-	-		2" - 12"			41261	POA

** Accessories not included, refer to Accessory Table Below.

Accessories

Item	Pace Model	Size Range	Capacity	Part No.	List Price
Pipe Stands	4031	1" - 4"	600 Lbs.	41037	POA
	4000	2" - 8"	900 Lbs.	41038	POA
	4033	2" - 14"	1,200 Lbs.	41039	POA
	4040	12" - 24"	4,000 Lbs.	41040	POA
Nipple Bracket	4037	Fits Model 1021 / 22 / 23 / 2021	-	41035	POA
	4045	4" - 12" Fits Model 1012 / 1112	-	41512	POA
Mounting Feet	4039	Fits Portable Roll Groovers and Model 1000	-	41034	POA
	4046	PA Mounting Feet	-	41013	POA
Porta-Bore	3013	Up to 4 1/4" Holes in Pipe 1 1/4" - 12"	-	41049	POA

See latest catalog or technical data sheets for specific approvals, listings, and design parameters.
POA = Price on availability. Prices subject to change without notice.

Roll Selection Chart

Machine	Pipe	Size	Top		Size	Bottom		Parts	Part Number	List Price
			Part No.	List Price		Part No.	List Price			
1021, 1023, 2021	Sch. 40	1 ¹ / ₄ " – 1 ¹ / ₂ "	41262	\$360.00	1 ¹ / ₄ " – 1 ¹ / ₂ "	41281	\$261.00			
		2" – 3 ¹ / ₂ "	41263	\$314.00	2" – 3 ¹ / ₂ "	41282	\$242.00			
		4" – 6"	41264	\$279.00	4" – 6"	41283	\$366.00			
		8" – 12"	41265	\$279.00	8" – 12"	41284	\$437.00			
	Std. Wall	14" – 16"	41266	\$262.00	14" – 16"	41285	\$480.50			
		18" – 24"	41267	\$262.00	18" – 24"	41286	\$480.50			
	Copper Tube	2" – 8"	41268	\$314.00	2" – 8"	41287	\$242.00	Depth Gauge 4043	41509	POA
1010, 2010	Sch. 10, Sch. 40	1 ¹ / ₂ " – 6"	41269	\$262.00	1 ¹ / ₂ "	41288	\$242.00			
			–	–	2" – 3 ¹ / ₂ "	41289	\$242.00			
			–	–	4" – 6"	41290	\$352.00			
	Sch. 10	8" – 12"	41270	\$262.00	8" – 12"	41291	\$352.00			
1040, 2040	Sch. 40	1" – 1 ¹ / ₂ "	41271	\$215.00	1" – 1 ¹ / ₂ "	41292	\$215.00			
		1" – 6"	41272	\$190.00	1" – 6"	41293	\$180.00			
		2" – 6"	41273	\$215.00	–	–	–			
	Sch. 10	8" – 12"	41274	\$190.00	8" – 12"	41294	\$297.00			
	Copper Tube	2" – 8"	41275	\$191.50	2" – 8"	41295	\$184.00	Depth Gauge 4021	41510	POA
1012, 1112, 2112	Sch. 40	1" – 1 ¹ / ₂ "	41276	\$215.00	1" – 1 ¹ / ₂ "	41296	\$215.00			
		2" – 6"	41277	\$215.00	2" – 6"	41297	\$180.00			
		8" – 12"	41278	\$215.00	8" – 12"	41298	\$299.50			
	Copper Tube	2" – 8"	41506	\$215.00	2" – 8"	41507	\$184.00	Depth Gauge 4021	41510	POA
1021, 1022, 1023, 2021	SS 10 Ga.				2" – 3 ¹ / ₂ "	41299	POA			
					4" – 6"	41500	POA			
					8" – 12"	41501	POA			
					14" – 16"	41504	POA			
					18" – 24"	41505	POA			
1040, 1041, 1112, 2112	SS 10 Ga.				2" – 6"	41502	POA			
					8" – 12"	41503	POA			
1034, 1039	Sch. 40	1 ¹ / ₄ " – 6", w/ brg.	41279	POA				1034 Drive Shaft 1 ¹ / ₄ " – 6"	41511	POA
								1039 Drive Shaft 1 ¹ / ₄ " – 6"	41513	POA
									Depth Gauge 4021	41510
1039	Copper Tube	2" – 8", w/ brg.	41280	POA				Depth Gauge 4021	41510	
1066	Copper Tube	2" – 8", w/ brg.	41508	POA				Drive Shaft 2" – 8"	41514	POA
								Depth Gauge 4021	41510	POA

Introduction
 Couplings & Fittings
 Mechanical Tees
 Valves
 Circuit Balancing Valves
 Accessories
 Copper Systems
 Stainless Steel Systems
 Plain End Systems
 HDPE Systems
 G-MINE PVC Systems
 Gaskets & Spare Parts
 Preparation Equipment
 Miscellaneous
 Indexes

Grooved Couplings – Pieces Per Carton/Case

Nominal Size	#705 Flex Coupling	#707 HD Flex Coupling	#772 Rigid Coupling	#71 Flange Adapter	#770 Heavy Duty Coupling	Nominal Size	#716 Reducing Coupling
1 1/4"	32	-	32	-	-	2" x 1 1/2"	20
1 1/2"	32	480	28	-	-	2 1/2" x 2"	36
2"	480	385	385	210	280	3" x 2"	12
2 1/2"	350	350	350	210	-	3" x 2 1/2"	9
3"	270	240	240	124	120	4" x 2"	6
4"	175	150	150	124	60	4" x 2 1/2"	6
5"	96	80	100	30	-	4" x 3"	6
6"	80	64	80	30	-	5" x 4"	80
8"	48	36	44	30	-	6" x 4"	64
10"	24	60	24	24	-	6" x 5"	64
12"	20	20	20	24	20	8" x 6"	36
14"	-	12	-	-	-	-	-
16"	-	12	-	-	-	-	-
18"	-	6	-	-	-	-	-
20"	-	N/A	-	-	-	-	-
24"	-	N/A	-	-	-	-	-

Grooved Fittings – Pieces Per Carton/Case

Nominal Size	#210 90 Elbow	#201 45 Elbow	#219 Tee	#260 Cap	Nom Size	#250 Conc Reducer	#251 Ecc Reducer
1 1/4"	40	45	28	287	2 1/2" x 1 1/4"	36	-
1 1/2"	27	39	28	210	2 1/2" x 1 1/2"	36	-
2"	18	24	24	140	2 1/2" x 2"	36	-
2 1/2"	8	15	10	84	3" x 1 1/2"	45	-
3"	12	8	12	56	3" x 2"	60	30
4"	168	288	46	30	3" x 2 1/2"	30	30
5"	105	140	75	392	4" x 2"	243	144
6"	63	90	48	288	4" x 2 1/2"	243	144
8"	28	48	24	160	4" x 3"	243	144
10"	15	18	-	96	5" x 3"	147	147
12"	8	14	-	63	5" x 4"	147	98
14"	-	-	-	-	6" x 2"	72	-
16"	-	-	-	-	6" x 2 1/2"	72	-
18"	-	-	-	-	6" x 3"	72	72
20"	-	-	-	-	6" x 4"	216	216
24"	-	-	-	-	6" x 5"	216	144
-	-	-	-	-	8" x 3"	80	-
-	-	-	-	-	8" x 4"	80	-
-	-	-	-	-	8" x 5"	80	-
-	-	-	-	-	8" x 6"	80	-



Grooved Fittings – Pieces Per Carton/Case					
<i>Nominal Size</i>	<i>#730 Mechanical Tee</i>	<i>Nominal Size</i>	<i>#730 Mechanical Tee (cont.)</i>	<i>Nominal Size</i>	<i>#221 Reducing Tee</i>
2" x 1/2"	15	4" x 1/2"	12	2" x 2" x 1 1/2"	24
2" x 3/4"	15	4" x 3/4"	12	3" x 3" x 1"	12
2" x 1"	15	4" x 1/2"	12	3" x 3" x 2"	12
2" x 1 1/4"	26	4" x 1 1/4"	12	4" x 4" x 2"	46
2" x 1 1/2"	12	4" x 1 1/2"	12	4" x 4" x 3"	46
2 1/2" x 1 1/2"	14	4" x 2"	10	6" x 6" x 2"	48
2 1/2" x 3/4"	14	4" x 2 1/2"	10	6" x 6" x 3"	48
2 1/2" x 1"	14	4" x 3"	8	6" x 6" x 4"	48
2 1/2" x 1 1/4"	32	5" x 2"	8	-	-
2 1/2" x 1 1/2"	20	5" x 2 1/2"	8	-	-
3" x 1/2"	16	6" x 1 1/2"	8	-	-
3" x 3/4"	16	6" x 2"	7	-	-
3" x 1"	16	6" x 2 1/2"	7	-	-
3" x 1 1/4"	18	6" x 3"	6	-	-
3" x 1 1/2"	16	6" x 4"	6	-	-
3" x 2"	12	8" x 2 1/2"	4	-	-
-	-	8" x 3"	4	-	-
-	-	8" x 4"	4	-	-

Copper System Grooved Couplings – Pieces Per Carton/Case		
<i>Nominal Size</i>	<i>#672 Rigid Coupling</i>	<i>#61 Flange Adapter</i>
2"	52	108
2 1/2"	40	108
3"	20	108
4"	20	108
5"	12	108
6"	80	108
8"	60	-

Introduction
 Couplings & Fittings
 Mechanical Tees
 Valves
 Circuit Balancing Valves
 Accessories
 Copper Systems
 Stainless Steel Systems
 Plain End Systems
 HDPE Systems
 G-MINE PVC Systems
 Gaskets & Spare Parts
 Preparation Equipment
 Miscellaneous
 Indexes



Table with 6 columns: Part No., Page, Part No., Page, Part No., Page, Part No., Page, Part No., Page. Lists various part numbers and their corresponding page numbers in a grid format.

See latest catalog or technical data sheets for specific approvals, listings, and design parameters.
POA = Price on availability. Prices subject to change without notice.

www.grinnell.com



Table with 6 columns: Part No., Page, Part No., Page, Part No., Page, Part No., Page, Part No., Page. Lists various mechanical parts and their corresponding page numbers.

See latest catalog or technical data sheets for specific approvals, listings, and design parameters.
POA = Price on availability. Prices subject to change without notice.

www.grinnell.com

Model No.	Page	Model No.	Page
#71 Flange Adapter Replacement "E" EPDM Gasket.....	102	#405 Flexible Coupling 316 SS with Grade "EN" Tri-Seal Gasket.....	75
#71 Flange Washer Adapter Carbon Steel.....	103	#407GG Dielectric Waterway Transition Fitting Grooved x Grooved, IPS x CTS	72
#71 Grooved Flange Adapter ANSI 150 lbs. with Grade "E" EPDM Gasket	17	#407GT Dielectric Waterway Grooved x Thread	72
#71 Grooved Flange Adapter DN10/DN16 with Grade "E" EPDM Gasket	17	#407T Dielectric Waterway Male Thread x Male Thread	73
#71 Nut, Bolt, and Gasket Kit	108	#410 90° Elbow 304 SS & 316 SS, Sch. 10.....	76
#201 and #301 Grooved 45° Elbow	19	#419 Tee, 304 SS & 316 SS, Sch. 10.....	77
#201LR and #301LR – Grooved 45° Long Radius Elbow	23	#421 Reducing Tee, 304 SS & 316 SS, Sch. 10.....	78
#210 and #310 Grooved 90° Elbow	18	#441 Flange Adapter Nipple 150 lbs. 304 SS, Sch. 10.....	79
#210LR and #310LR – Grooved 90° Long Radius Elbow	22	#441 Flange Adapter Nipple PN16/PN10 304 SS, Sch. 10.....	79
#211 and #311 – Grooved 11 ¹ / ₄ ° Elbow.....	21	#450 Concentric Reducer, 304 SS & 316 SS, Sch. 10	80
#212 and #312 – Grooved 22 ¹ / ₂ ° Elbow.....	20	#451 Eccentric Reducer, 304 SS & 316 SS, Sch. 10.....	81
#219 and #319 – Grooved Tee	28	#460 Cap, 304 SS & 316 SS, Sch. 10.....	77
#221 – Grooved Reducing Tee	29	#472 Rigid Coupling 316 SS with Grade "EN" Gasket	74
#250 – Grooved Concentric Reducer	34	#472 Rigid Coupling 316 SS with Grade "EN" Tri-seal Gasket.....	74
#251 – Grooved Eccentric Reducer	36	#577 Rigid Coupling - WRAS Recommended for Potable Water	9
#260 and #360 – Grooved Cap	46	#577 Rigid Tri-Seal Coupling with Grade "E" EPDM Tri-Seal Gasket	9
#301 -3D, #301 - 5D, #301 -6D, Long Radius 45° Elbow	25	#577 Rigid Coupling with Grade "E" EPDM.....	8
#303 - 3D, #303 - 5D, #303 - 6D, Long Radius 30° Elbow.....	25	#577 Rigid Coupling with Grade "T" Nitrile Gasket.....	8
#306 - 3D, #306 - 5D, #306 - 6D, Long Radius 60° Elbow.....	24	#590 Grooved Check Valve, EPDM	61
#310 - 3D, #310 - 5D, #310 - 6D Long Radius 90° Elbow.....	24	#601 Grooved 45° Elbow.....	69
#312 - 3D, #312 - 5D, #312 - 6D, Long Radius 22 ¹ / ₂ ° Elbow	26	#61 Flange Adapter with Grade "EN" EPDM Gasket.....	68
#313 - 3D, #313 - 5D, #313 - 6D, Long Radius 11 ¹ / ₄ ° Elbow	26	#610 Grooved 90° Elbow.....	69
#314 Grooved Lateral	41	#618 Reducing Tee Grooved x Grooved x Cup	71
#315 Groove x Male Thread – Adapter 90° Elbow	27	#619 Tee	69
#316 Reducing Base Support Elbow, Groove x Flange	27	#621 Reducing Tee Grooved x Grooved x Grooved	71
#320 Groove x Male Thread – Tee	28	#640 Pivot-Bolt Rigid Couplings with Grade "EHT" EPDM Center-Stop Push-On Style Gasket	68
#321 – Grooved Reducing Tee	30	#650 Grooved Concentric Reducer.....	70
#323 Groove x Male Thread – Reducing Tee with Threaded Branch	32	#652 Grooved Reducer Grooved x Cup.....	70
#324 Grooved Wye	43	#660 Cap.....	70
#325 Grooved Reducing Lateral	42	#672 Rigid Couplings with Grade "EN" Tri-Seal Gasket.....	68
#327 – Grooved Cross	45	#702 Outlet Coupling Grade "E" Gasket, Female Threaded End	14
#330 Grooved Tee Wye	44	#702 Outlet Coupling Grade "E" Gasket, Grooved End, Painted*	15
#331 Grooved Reducing Tee Wye	43	#702 Outlet Coupling Grade "E" Gasket, Male Threaded End.....	14
#341 Groove x Flange – Adapter 150#.....	49	#705 Flexible Coupling with Grade "E" EPDM Gasket.....	10
#342 Groove x Flange – Adapter 300#	49	#705 Flexible Coupling with Grade "E" EPDM Tri-Seal Gasket.....	11
#350 – Grooved Concentric Reducer	35	#707 Heavy-Duty Flexible Coupling with Grade "E" EPDM or Grade "T" Nitrile Gasket.....	12
#351 – Grooved Eccentric Reducer	36	#707 Heavy-Duty Flexible Coupling w/ Grade "E" EPDM Tri-Seal Gasket..	13
#363 Cast – Grooved Cap with 3/4" Tap	47	#716 Reducing Coupling with Grade "E" EPDM Gasket.....	13
#372 Groove x Male Thread – Reducer	38	#72899 Replacement Gaskets	98
#380 Female Thread Adapter, Groove x Female Pipe Thread	41	#730 Mechanical Cross – Grooved with Grade "E" or "T" Nitrile Gasket...	57
#391 Groove x Male Thread – Adapter Nipple	39	#730 Mechanical Cross – Threaded with Grade "E" or "T" Nitrile Gasket..	56
#392 Groove x Groove – Adapter Nipple	39	#730 Mechanical Tee – Grooved with Grade "E" or "T" Nitrile Gasket.....	55
#393 Groove x Plain – Adapter Nipple.....	40	#730 Mechanical Tee – Threaded with Grade "E" Gasket.....	53
#395 Hose Adapter Nipple, Groove x Hose	40	#730 Replacement "E" EPDM Gasket	104
#397 Groove x Groove – Swaged Nipple.....	50	#770 High Pressure Rigid Coupling with Grade "E" EPDM Gasket	16
#398 Groove x Male Thread – Swaged Nipple	51	#772 Rigid Coupling with Grade "E" EPDM Gasket	6
#399 Groove x Plain – Swaged Nipple	52	#772 Rigid Coupling with Grade "E" EPDM Tri-Seal Gasket	7
#401 45° Elbow, 304 SS & 316 SS, Sch. 10.....	76	#780 Snap Coupling with Grade "E" EPDM Gasket or Grade "T" Nitrile Gasket.....	16
#405 Flexible Coupling 316 SS with Grade "EN" Gasket.....	75		

See latest catalog or technical data sheets for specific approvals, listings, and design parameters.
 POA = Price on availability. Prices subject to change without notice.



Model No.	Page	Model No.	Page
#901 Plain End 45° Elbow	83	#CB800 Flange x Flange – Circuit Balancing Valve	64
#901LR Plain End Long Radius 45° Elbow	83	#CB800 Groove x Groove – Circuit Balancing Valve	64
#909 Plain End Coupling with Grade “E” EPDM Gasket or Grade “T” Nitrile Gasket	82	#CB800 Solder x Solder – Circuit Balancing Valve	63
#910 Plain End 90° Elbow	82	#CB800 Thread x Thread – Circuit Balancing Valve	63
#910LR Plain End Long Radius 90° Elbow	83	#CV-1 Grooved Check Valve, EPDM	61
#914 Plain End Lateral	85	#CV-1 Grooved Check Valve, Spare Parts	62
#919 Plain End Tee	84	#ITGM Insertion Tool	98
#921 Reducing Tee Plain End	88	#S810 Groove x Flange ANSI – Suction Diffuser	67
#924 Plain End True Wye	84	#S853 Grooved Wye Strainer	66
#927 Plain End Cross	84	#S855 Grooved Tee – Type Strainer	66
#941 Flange Adapter 150 lbs.	87	#TD830, Triple Duty Valve, Flow Control Type	62
#942 Flange Adapter 300 lbs.	88	Accessories	110
#960 Plain End Cap (Bull Plug)	85	Copper System Grooved Couplings – Pieces Per Carton/Case	113
#991 Adapter Nipple – Plain x Thread	86	Coupling Nut and Bolt Kit	108
#992 Adapter Nipple – Plain x Grooved	87	Differential Measuring Computer	65
#993 Adapter Nipple – Plain x Plain	87	GRINNELL Gasket Lubricant	109
#999 Plain End Swaged Nipple	86	GRINNELL Gasket Styles, Grades and Recommendations	5
#9094 HDPE Flange Coupling with Grade “E” EPDM Gasket	89	GRINNELL Silicone Gasket Lubricant	109
#9095 HDPE Coupling with Grade “E” EPDM Gasket	89	Grooved Couplings – Pieces Per Carton/Case	112
#9097 HDPE Transition Coupling	89	Grooved Fittings – Pieces Per Carton/Case	112
#72900 SDR Pipe	90	Grooved Fittings – Pieces Per Carton/Case	113
#72901 SDR Pipe with Coupling	90	HDPE – #9094 Replacement Gaskets “E”	107
#72904 Coupling	91	HDPE – #9095 Replacement Gaskets “E”	107
#72905 Spline x Solvent Weld Coupling	91	HDPE – #9097 Replacement Gaskets “E”	108
#72906 Spline x Plain End Nipple	93	Insulation Kits for #CB800 Circuit Balancing Valves	65
#72907 Spline x Groove Nipple	93	Phenolic Washer (for #61 Flange Adapter)	106
#72908 Spline x Male Thread Nipple	93	Pipe Tape	109
#72909 Plain End x Male Thread Nipple	94	Replacement Gaskets – EPDM “E” Gaskets For # 716 Reducing Coupling	101
#72910 90° Elbow	94	Replacement Gaskets – EPDM “E” Gaskets For #909 Plain End Coupling	107
#72911 Spline x Spline Nipple	94	Replacement Gaskets – EPDM “E” Gaskets For #780 Snap Coupling	102
#72912 45° Elbow	95	Replacement Gaskets – EPDM “E” Gaskets, For #577, #772, #770, #705, #707	99
#72913 90° Sweep	95	Replacement Gaskets – Grade “EHT” EPDM Center-Stop Push-On Style Gasket for #640 Coupling	105
#72914 45° Sweep	95	Replacement Gaskets – Grade “EN” EPDM (for #61 Flange Adapter)	106
#72915 Cap	96	Replacement Gaskets – Grade “EN” Tri-Seal (for #672 Coupling)	105
#72916 Flange Adapter 150psi	96	Replacement Tri-Seal Gaskets – EPDM “E” Gaskets, For #577, #772, #770, #705, #707	100
#72917 Tee	96	Replacement WRAS Gaskets – EPDM “E” Gaskets, For #577, Recommended for Potable Water	101
#72918 Reducing Tee	97	Roll Groover Mini-Mite 2” – 8” Copper Tube #1039-66 Ratchet Hand Crank or Chucked into a Ridgid® 300	73
#72919 Male Thread x Female Thread Reducing Coupling	91	Roll Grooving Machine Selection Chart	110
#72930 Outlet Coupling	92	Roll Selection Chart	111
#72940 Male Thread x Female Thread Outlet Coupling	92	Table of Contents	2
#72999 Spline	97		
#B302 Grooved Butterfly Valve – Accessories	59		
#B302 Grooved Butterfly Valve – EPDM or Nitrile	58		
#B308 Grooved Butterfly Valve, EPDM or Nitrile – D.I. Nickle Plated, Gear Operator	59		
#B680 Copper System Butterfly Valve Grooved, EPDM, with Lever Handle or Gear Operated	73		
#B8101 Low Profile Butterfly Valve with Lever Handle	60		
#BN302 Grooved Butterfly Valve – EPDM NSF Approved	58		
#BV835 Grooved Ball Valve with Lever Handle	60		
#CB800 Circuit Balancing Valves – Accessories	65		

Introduction
Couplings & Fittings
Mechanical Tees
Valves
Circuit Balancing Valves
Accessories
Copper Systems
Stainless Steel Systems
Plain End Systems
HDPE Systems
G-MINE PVC Systems
Gaskets & Spare Parts
Preparation Equipment
Miscellaneous
Indexes

www.grinnell.com

Select Middle East Region on the map

See latest catalog or technical data sheets for specific approvals, listings, and design parameters.
 POA = Price on availability. Prices subject to change without notice.



Grinnell

Customer Service:
United Arab Emirates (Dubai)
PO Box 61355
Warehouse TB01, R/A 8
Jebel Ali Free Zone
Tel: +971 (0)4 883 8689
Fax: +971 (0)4 883 8674
E-mail: infoAE@tyco-bspd.com

www.grinnell.com

Select Middle East Region on the map.